

2018 - 2019

HUNTINGTON BRASS 海廷頓水龍頭

浴室龍頭 · 廚房龍頭 · 浴室配件





HUNTINGTON
B R A S S

CONTENTS 目錄

01 品牌理念

03 產品優勢

05 產品特色

07 無鉛能力

09 抗菌能力

11 認證資訊

13 浴室龍頭

15	Product Features	浴室龍頭產品特色
17	Dazzle	迪佐
18	Vogue	樂活
19	Rotunda	星動
21	Elliptic	伊利普
22	壓力平衡龍頭
23	Splice	普萊斯
25	掛牆恆溫龍頭
27	Casement	凱西蒙
29	Portico	波帝克
31	Trim	魔方
33	Edin	伊登
34	Essence	伊聖斯
35	Crisscross	酷仕
36	Ultra	歐賽
37	Vintage	干邑
38	Flicker	菲利克
39	Waterfall	瀑布

41 廚房龍頭

43	Touch Sensor Products	觸控產品
----	-----------------------	------

53 不鏽鋼龍頭 - 浴室&廚房

55 單把掛牆淋浴、浴缸雙花灑產品

57 Jazz 爵士 - 掛牆淋浴、浴缸置物盒產品 NEW

61 入牆淋浴系列組合

63	Splice	普萊斯
65	Casement	凱西蒙
68	入牆壓力平衡閥體介紹
69	Portico	波帝克

71 單把落地浴缸龍頭

73 浴室配件

75	Casement	凱西蒙
76	Rotunda	星動
77	Vintage	干邑
77	Edin	伊登
78	Sophis	蘇菲
79	Rondo	蘭朵

81 淋浴配件

83	排水組
85	淋浴間配件
96 無鉛銅鍛進水彎頭
97	浴室配件

99 銀髮系列產品 NEW

103 產品尺寸工程圖

105	浴室龍頭
116	廚房龍頭
118	不鏽鋼龍頭
119	淋浴配件
125	銀髮系列產品

品牌理念 BRAND CONCEPT



歷史沿革

Huntington Brass 為美國精品龍頭品牌，母公司創立於1979年，專注於OEM和ODM之水龍頭、浴室配件等高端衛浴五金產品的製造和銷售。為了提供顧客頂級的產品與最貼心的服務，“Huntington Brass”於1989年註冊商標為自有品牌，在美國市場銷售至今已近30年。

精品品牌

Huntington 音譯為「海廷頓」，其無鉛水龍頭是美國五星級酒店、豪宅、政府機關等指定品牌；除了無鉛無毒、抗菌防污、環保省水等…功能，海廷頓更專注於極致的工藝設計與符合國際的認證標準，並提供世界各國多樣化產品選擇。

社會責任

身為國際頂尖品牌，除了保證優良的產品品質及完善的銷售服務，「海廷頓」更榮獲各項國際認證，值得您的信賴。在多項專業認證中，可區分為五大類，包含無鉛、飲水、品質、環境保護及職場安全等。除了本身的企業責任之外，海廷頓更承諾在環境保護及擔負起員工安全的社會責任。

堅持「處處為他人著想」，用心體貼的品牌策略

貼近人心、以完美的客戶體驗為導向，堅持給予顧客最好的產品及貼心售後服務。

對綠色環保與珍愛地球不遺餘力，希望能給下一代安全、健康、純淨的生活。

產品優勢

PRODUCT ADVANTAGES

無鉛無毒 抗菌節水

本產品採用無鉛銅鍍鑄造與無毒塑料製作，奈米銀抗菌劑作為表面塗層，並以先進PVD真空鍍膜來抗氧防腐，同時獲得美國節水認證，兼具性能與美學雙優勢。



無鉛

- 採用自煉無鉛銅鍍鑄造，皆通過廠內實驗室抽樣檢測，符合國際認證標準。
- 使用精煉黃銅鑄造成型，鉛含量 $\leq 0.25\%$ ，符合AB1953國際標準。
- 鉛析出量僅 $0.5 \mu\text{g/L}$ ，意即僅有美國與中國標準($5 \mu\text{g/L}$)的1/10，讓您遠離鉛危機。
- 符合NSF 61-9、AB1953等嚴格標準，守護您的用水安全。

節水

- 擁有WaterSense、CALGreen等美國認證，節水責任（可達 5.7 L/min ）讓我們協助您。
- 符合台灣省水標章標準（ 9 L/min ），輕鬆省下1/4的水量，讓您在用水的同時也能隨時為這片土地盡一份心力。
- 搭配起泡器的柔性出水感，省水的同時仍保有清新舒爽的用水體驗。

抗菌防污

- 運用奈米銀抗菌劑作為表面塗層，使產品自主抗菌，擁有自潔能力。
- 塗層具99%抗菌率，通過JIS Z 2801標準，健康安心。
- 防手污、不沾手印、不留水漬、節省清潔時間，給予您更多自由時光。

極致工藝

- 引進最先進PVD真空鍍膜技術，抗氧防腐能力強，強化表面膜層硬度，通過美國ASTM嚴格標準。
- 產品膜層均勻細緻，堅固耐用，不留刮痕。
- 雙層電鍍鍍，增強抗腐蝕能力，同時增加表面色彩的細膩度、豐富度。
- 製程不含六價鉻，工藝環保無汙染，和您一起愛護生態。

塑件無毒

- 龍頭內部流水通道皆採取低鉛銅材及無毒塑料製作。
- 更全面的讓您的飲用水源遠離重金屬與其他毒性的危害。

品味非凡

- 引進低壓鑄造機具，在提供生產品質的同時，更增加產品外觀造型豐富度。
- 以長年的市場分析基礎，搭配精煉造型設計能力，讓產品兼具性能與市場美學雙優勢。

產品特色

FEATURES



Health 健康



無鉛

原料銅材與產品鉛析出量皆，符合國際無鉛認證標準。



塑件無毒

龍頭配件產品通過美國 NSF 標準認證，所有過水塑料皆達到美國直飲水檢測無毒標準，帶給消費者最佳安心保障。



抗菌防污

表面處理選用含奈米銀的抗菌劑，持久耐用的有機塗層，力求每項產品擁有高規格自潔能力保障您的用水健康。

Environmental Protection 環保



節水省水

產品出水量除符合國際節水認證外，並使用控制出水，減少飛濺的龍頭零件，與您珍惜每份珍貴水資源。

Technology 技術



SilkMove

使用通過北美cUPC認證的抗磨耐用高硬度陶瓷軸心，透過獨特SilkMove 技術讓龍頭操作更順暢使用壽命更高。



快速拆裝

體恤您的忙碌生活，為此部分產品配置了新穎的快拆接管結構，簡單易操作的拆卸方法，增加管材替換的簡便性。



拉伸式花灑頭

花灑頭採用拉伸式功能設計，讓龍頭風格貼近家居時尚裝潢外，更兼具出水穩定，操作便利等功能性。



360 度轉動花灑頭

360°花灑頭轉動設計讓龍頭操作便利，出水範圍大且穩定。



本體可旋轉

水龍頭本體使用變動式可旋轉結構設計，讓出水管控制桿筒可選擇置左或置右，便利快速裝卸、體貼客戶操作使用。



雙功能出水花灑頭

雙功能出水花灑頭設計，操作便利，並提供花灑直噴和擴散雙出水功能等雙功能性設定。



恆溫 38 度

閥芯通過北美的cUPC認證，龍頭自動感應冷熱水進水溫度變化並穩定調節出水最適溫度為38°C，精準恆溫科技不再忽冷忽熱。



冷熱壓力平衡

閥芯通過北美的cUPC認證，可自動感應冷熱水進水壓力並進行自動補償以穩定綜合出水溫度，水溫極限不超過48.9°C，精準控溫科技有效防止燙傷。

Finish 表面處理



PVD 表面處理

多元化 PVD 鍍膜技術，產品兼具美學與功能性製程不含六價鉻，工藝環保無污染，讓您安心享受水的純淨美好。



Ultra Bright

高品質的電鍍技術，確保產品表面抗磨損，長期光亮如新，20um鍍鍍層標準，更大大增強龍頭的抗腐蝕能力。

Service 服務



零維修服務

自購買日起算1年內，在正常安裝、使用及清潔、維護下，家庭自用產品有任何瑕疵，免費全產品換新，讓您更放心。



設計造型

不僅在無鉛、節水、抗菌等性能上要求高效率低耗能，同時追求產品外觀美學，使龍頭成為生活品味的一部分。

無鉛能力

LEAD-FREE CAPABILITY



遠離鉛害 守護健康

「鉛」具有神經毒性的重金屬元素，它會經由呼吸系統、消化系統等管道到人體體內，對人體造成嚴重的傷害，無鉛水龍頭已成為現代消費者使用之新趨勢。

製程改良

為了給您和家人最安心的高品質生活，Huntington Brass不惜投入大量資金與心力，從原材料配方研發及熔煉工藝入手，確保原料鉛含量絕對低於0.25%，大幅降低鉛金屬造成毒害的機率。除此之外，Huntington Brass更加強工藝流程，抑制鉛的進一步析出，使鉛析出量僅0.5ug/L，減少龍頭水中鉛含量。

低污染材料

為使顧客能更安心使用我們的產品，Huntington Brass 致力由源頭的熔煉工藝入手；從原材料配方研發，使用含鉛量極低的無鉛銅原料，導入生產銅條、銅錠之優化工藝流程；也利用各金屬活性不同的化學特性，抑制鉛的進一步析出，使產品的鉛含量及鉛析出量皆大大減少。

把關檢驗

Huntington Brass 透過直讀光譜分析儀、金相電子顯微鏡等設備，針對各批銅材原料樣本進行成份分析，同時進行銅質抗脫鋅測試，避免銅材經長年使用，與水質接觸而流失鋅質，並符合NSF61-9、AB1953等國際認證標準。Huntington Brass 以層層嚴格標準，為您的水質安全作把關，提供您於家庭用水上，最安心的承諾。

抗菌能力

ANTI-BACTERIAL CAPABILITY

隱形危害 不得忽視

日常生活用品，如鍵盤、電話，細菌量多得驚人，尤其是四周富含水分的水龍頭，細菌多到會侵害您的身體，所以具備抗菌能力水龍頭，則是消費者選購時不能忽視一環。

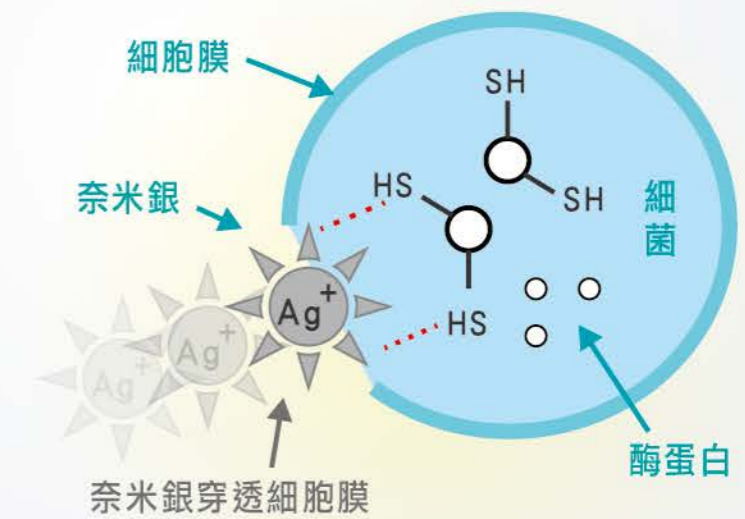

▲ 抗菌原理

奈米銀抗菌

為此，Huntington Brass 致力於研究新的表面處理塗層技術，選用含奈米銀的抗菌劑，作為特殊塗層的內容物，讓擁有此表面處理的產品於本身就能抵抗外來菌物，如大腸桿菌、金黃色葡萄球菌等的侵害，抗菌率高達99%。此處理通過 JIS Z 2801 的檢測標準，能保障人體健康，照顧您的衛生安全。

耐久塗層保護

特殊的有機塗層，讓我們產品具有自潔能力，並經過6項持久力測試，包含抗腐蝕的CASS鹽霧測試12小時、附著力的百格測試、水浸測試24小時、抗化學的CSA測試、耐磨度的落砂測試，及結合力的冷熱循環系統；這些均達DS-150標準，持久耐用的抗菌塗層，時時保障您的用水健康。擁有自潔能力的產品，Huntington Brass 讓您遠離病毒危害，更為您省去許多清潔的動作，下班後及假日能有更多時間享有您的自主空間，與家人度過美好的休憩時光，提升您的生活品質。

CERTIFICATION

認證資訊

五大保證 值得信賴

Huntington Brass 透過持之以恆的努力，榮獲各項國際認證的肯定，成為值得您信賴的品牌。在我們多項認證中，檢測重點共分為五類。



無鉛 Lead-Free



美國加州無鉛法案
AB1953認證



美國衛生基金會
NSF認證



台灣LF無鉛標章

節水 Water Saving



美國環保署
水意識計畫節水認證



澳洲水標誌認證



加州綠能建築認證



澳洲節水效率標章

品質 Product Quality



美國國際管道暖通機
械認證協會UPC認證



國際標準化組織
ISO 9001

環境保護 Environmental Protection



ISO14001環境管理

職場安全 Workplace Safety



職業安全衛生認證：
OHSMS18001:1999



浴室龍頭

◆
Bathroom
Faucet

浴室龍頭產品特色

Bathroom Faucet Features



陶瓷閥芯

- 採用高品質陶瓷片，陶瓷片經過高壓壓制，成型後再進行精密研磨。
- 能達到50萬次開關壽命的高品質水準。通過NSF、CSA、WARS等，國際飲用水標準。

表面處理

- 產品經過精拋，環保電鍍厚色澤光亮，手感細膩。
- 通過鍍層厚度，24H鹽霧及淬火等三項嚴謹的測試。
- 電鍍過程進行嚴格監控，對產生的污水進行回收，處理後循環再用，保護環境。

進水軟管

- 使用TPE無毒橡膠材料製作（優於EPDM軟管材質），符合北美NSF61-9無毒要求。
- 外層為不銹鋼編織絲，確保軟管可長期承受高水壓，且可長期使用而不生鏽。

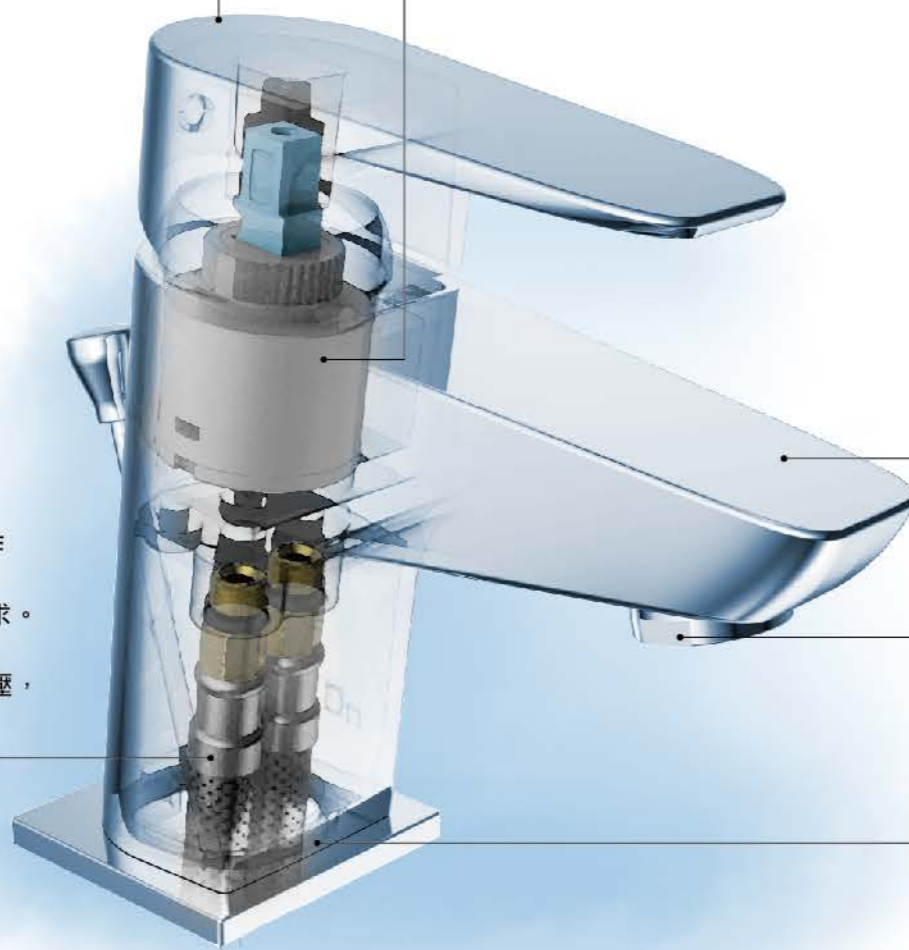

無鉛銅原料主體

- 使用精煉黃銅鑄造，鉛含量 $\leq 0.25\%$ 。
- 通過對水質要求嚴苛的美國NSF飲水標準認證，保證健康，無毒。
- 銅的性質穩定，抵抗水中酸鹼物質的腐蝕，同時也具有抑菌作用，防止水中微生物的滋養。



起泡器（水波器）

- 起泡器統一使用瑞士NEOPERL品牌產品。
- 產品通過NSF的cUPC、WARS等主要國家標準。
- 使用NEOPERL起泡器的龍頭出水柔軟，不濺水。



密封膠體

- 水龍頭密封水的橡膠件使用EPDM無毒橡膠製成。
- 耐高溫、耐高壓，是歐美認可的無毒材料，確保飲用水的無毒、健康。

Dazzle 迪佐



§ 2,700

W3180601-TW1

單把臉盆龍頭

金屬材質把手
無鉛銅材質主體
陶瓷閥芯(φ35)
含提拉式排水組



§ 2,700

S5180601-TW

單把掛牆淋浴龍頭

金屬材質把手
銅材質主體
陶瓷閥芯(φ35)
含單功能花灑, 花灑插座
1500mm花灑軟管



§ 4,300

W3580601-TW4

單把高腳臉盆龍頭

金屬材質把手
無鉛銅材質主體(一體式)
陶瓷閥芯(φ35)
含銅手按式排水組



§ 4,000

S5380601-TW

單把掛牆淋浴浴缸龍頭

金屬材質把手
銅材質主體
陶瓷閥芯(φ35)
含單功能花灑, 花灑插座
1500mm花灑軟管



Vogue 樂活



§ 3,500

W3180101-TW1

單把臉盆龍頭

金屬材質把手
無鉛銅材質主體
陶瓷閥芯(φ35)
含提拉式排水組



§ 4,500

S5180101-TW

單把掛牆淋浴龍頭

金屬材質把手
銅材質主體
陶瓷閥芯(φ35)
含單功能花灑, 插座
1500mm花灑軟管



§ 4,200

W3290101-TW4

單把臉盆龍頭

金屬材質把手
無鉛銅材質主體
陶瓷閥芯(φ35)
含銅手按式排水組



§ 4,800

S5380101-TW

單把掛牆淋浴浴缸龍頭

金屬材質把手
銅材質主體
陶瓷閥芯(φ35)
含單功能花灑, 插座
1500mm花灑軟管



§ 5,800

W3580101-TW4

單把高腳臉盆龍頭

金屬材質把手
無鉛銅材質主體(一體式)
陶瓷閥芯(φ35)
含銅手按式排水組



Rotunda 星動

NEW \$ 3,600

W8129101-TW4
單把臉盆龍頭

金屬材質把手
金屬材質主體
無鉛銅水路
陶瓷閥芯(Φ35)
含銅手按式排水組







\$ 3,800

W3280201-TW1
單把臉盆龍頭

金屬材質把手
無鉛銅材質主體
陶瓷閥芯(Φ35)
含提拉式排水組







\$ 7,000

W4580201-TW1
雙把3孔分離式
臉盆龍頭

金屬材質把手
無鉛銅材質主體
90°陶瓷閥芯
含提拉式排水組







\$ 8,200

S7380201-TW
雙把3孔分離式
浴缸龍頭

金屬材質把手
銅材質主體
90°陶瓷閥芯



\$ 3,000

W3123001-TW1
單把臉盆龍頭

金屬材質把手
無鉛銅材質主體
陶瓷閥芯(Φ35)
含提拉式排水組







\$ 5,000

W3680201-TW4
單把高腳臉盆龍頭

金屬材質把手
無鉛銅材質主體(分離式)
陶瓷閥芯(Φ35)
含銅手按式排水組







\$ 5,800

W8880201-TW4
單把2孔入牆
臉盆龍頭

金屬材質把手
無鉛銅材質主體
陶瓷閥芯(Φ35)
含銅手按式排水組







\$ 9,800

S9380201-TW
單把3孔分離式
浴缸龍頭

金屬材質把手
銅材質主體
陶瓷閥芯(Φ40)
塑膠手握花灑





\$ 4,500

W3480201-TW4
單把臉盆龍頭

金屬材質把手
無鉛銅材質主體
陶瓷閥芯(Φ35)
含銅手按式排水組







\$ 9,000

W4880201-TW14
雙把3孔分離式
入牆臉盆龍頭

金屬材質把手
無鉛銅材質主體
90°陶瓷閥芯
含銅手按式排水組







\$ 4,300

S5380201-TW
單把掛牆淋浴浴缸龍頭

金屬材質把手
銅材質主體
陶瓷閥芯(Φ35)
含單功能花灑·花灑插座
1500mm花灑軟管



Elliptic 伊利普



\$ 3,200

W3280701-TW4

單把臉盆龍頭

金屬材質把手
無鉛銅材質主體
陶瓷閥芯(Φ25)
含銅手按式排水組



\$ 6,500

W3580701-TW14

單把高腳臉盆龍頭

金屬材質把手
無鉛銅材質主體(一體式)
陶瓷閥芯(Φ35)
含銅手按式排水組



\$ 4,200

W3180701-TW1

單把臉盆龍頭

金屬材質把手
無鉛銅材質主體
陶瓷閥芯(Φ35)
含提拉式排水組



\$ 6,100

S5380701-TW

單把掛牆淋浴浴缸龍頭

金屬材質把手
銅材質主體
陶瓷閥芯(Φ35)
含單功能吸氣花灑, 花灑插座
1500mm花灑軟管



伊利普 - 智慧恆溫掛牆龍頭

Elliptic - Pressure Balance Faucets

智慧恆溫, 源自於您內心的渴望

智慧恆溫

壓力平衡

直覺操作

洗澡時水溫忽冷忽熱, 令人難以忍受!
一下超冷, 一下過燙, 這是水壓出了問題!
恆溫水龍頭, 解決浴室出水忽冷忽熱的痛苦!



智慧恆溫, 暢快沐浴

恆溫水龍頭使用壓力平衡閥芯
當冷熱水供水壓力變化差 $\pm 50\%$ 時
其出水口溫度會自動維持在
設定溫度的 $\pm 2^\circ\text{C}$ 以內
達到恆溫及避免水溫過燙的效果

小巧配件, 恆溫功臣

恆溫水龍頭內建的限溫蓋
可調節出水的最高或最低溫度
更俱備水流量調節功能

一指切換, 輕鬆雙用

本產品帶提拉換向功能
可輕鬆在出水口及
蓮蓬頭間切換出水

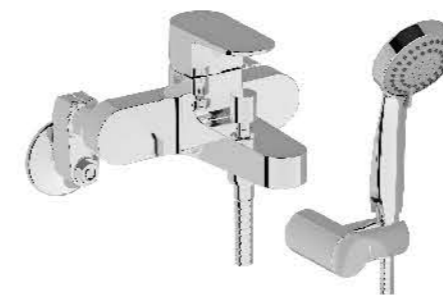

\$ 9,000

S5480701-TW

單把掛牆淋浴浴缸龍頭

金屬材質把手
銅材質主體
陶瓷壓力平衡閥芯(Φ40)
含三功能手握花灑, 花灑插座
1500mm花灑軟管



Splice 普萊斯



\$ 8,500

W8181801-TW4

單把臉盆龍頭

金屬材質把手
無鉛銅材質主體
陶瓷閥芯(Φ35)
含銅手按式排水組



\$ 4,500

W3181301-TW1

單把臉盆龍頭

金屬材質把手
無鉛銅材質主體
陶瓷閥芯(Φ35)
含提拉式排水組

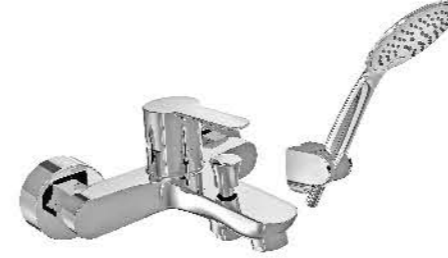

\$ 6,600

S5381301-TW

單把掛牆淋浴浴缸龍頭

金屬材質把手
銅材質主體
陶瓷閥芯(Φ35)
含3功能吸氣花灑, 花灑插座
1500mm花灑軟管



\$ 9,500

W8181834-TW4

單把臉盆龍頭

金屬材質把手
無鉛銅材質主體
陶瓷閥芯(Φ35)
含銅手按式排水組



鍍鉻+白漆



\$ 8,300

W3181331-TW1

單把臉盆龍頭

金屬材質把手
無鉛銅材質主體
陶瓷閥芯(Φ35)
含提拉式排水組



抗菌拉絲銀



NEW

\$ 9,500

W8181838-TW4

單把臉盆龍頭

金屬材質把手
無鉛銅材質主體
陶瓷閥芯(Φ35)
含銅手按式排水組



鍍鉻+黑漆



\$ 6,600

W3581301-TW4

單把高腳臉盆龍頭

金屬材質把手
無鉛銅材質主體(分離式)
陶瓷閥芯(Φ35)
含銅手按式排水組



普萊斯 - 掛牆恆溫龍頭

Splice - Wall Mounted Thermostatic Faucets

安全第一，從來就不是第二

- 智慧恆溫
- 安全定位
- 防燙設計
- 直覺操作

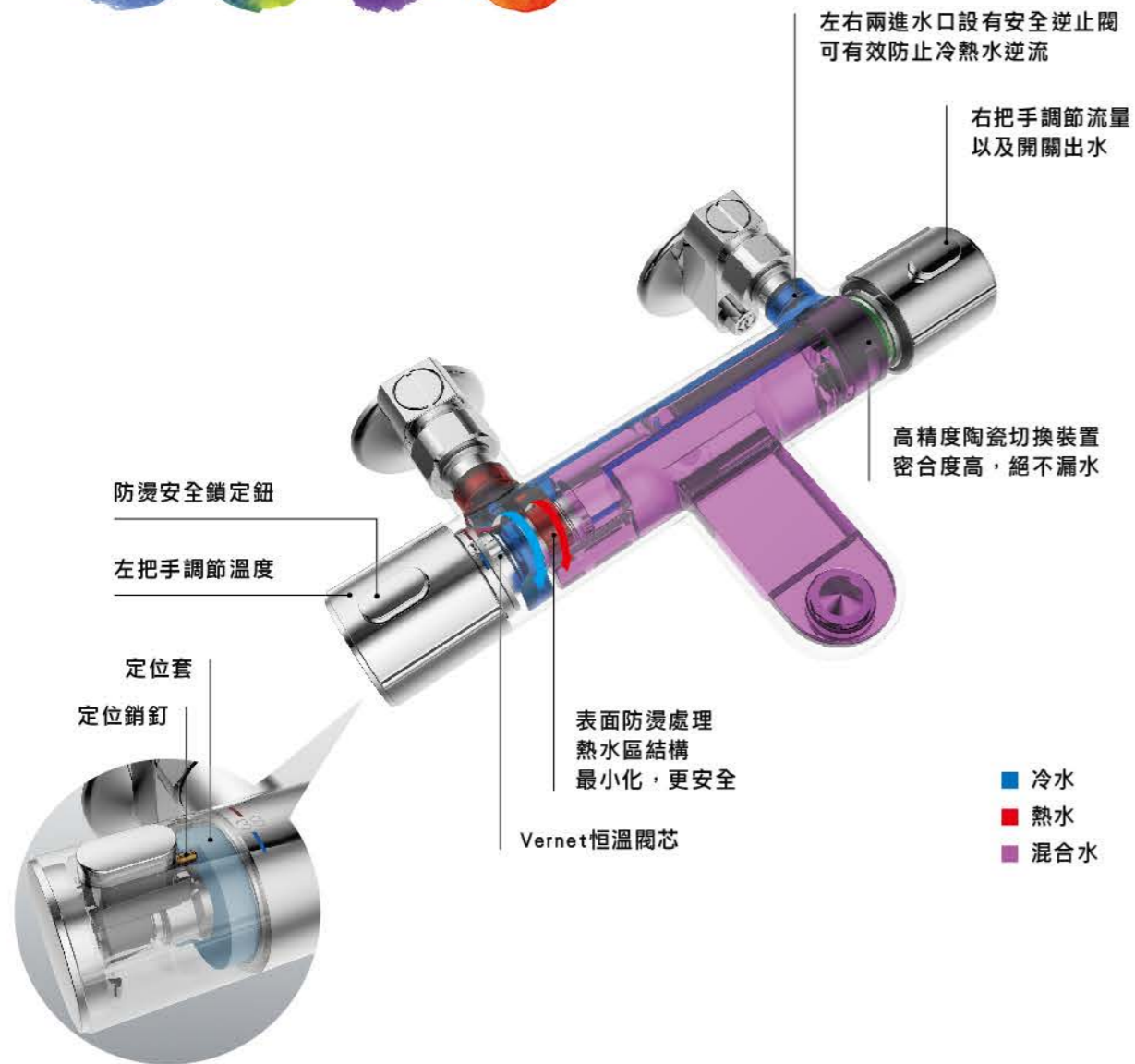

定位防燙傷

調溫把手內部設計有定位銷釘，出廠時已將龍頭的出水溫度設定在38°C，此時，把手的按鈕與本體的38°刻度對齊，藉此達到防燙傷目的。當用戶需要更高溫度時，可以按下按鈕，按圖示的旋轉方向向後方轉動把手（通過定位套定位，最大不超過48.9°C），向前轉動把手則可以降低溫度。如遇到冷水突然間無供應時，在5秒內，出水流量會小於1.9L/MIN，且溫度不超過48.9°C，從而達到防燙傷目的。

恆溫出水，洗的更暢快
防燙表面，使用更安全

假設在沐浴時有家庭成員也在用水，這種情況下水溫很可能無防備的急劇增加。恆溫技術可以防止發生此類情況產生。



46mm直徑的精緻設計



恆溫38度C防燙安全鎖定鈕
可快速調節溫度



表面防燙處理
熱水區結構最小化，更安全

§ 11,000

S5202401-TW1

掛牆淋浴恆溫龍頭

塑膠材質把手，銅材質主體
左把手調節溫度
右把手調節流量以及開關出水
Vernet恆溫閥芯
含3功能吸氣花灑，花灑插座
1500mm花灑軟管



§ 12,000

S5402401-TW1

掛牆淋浴浴缸恆溫龍頭

塑膠材質把手，銅材質主體
左把手調節溫度
右把手調節流量以及開關出水
Vernet恆溫閥芯
含3功能吸氣花灑，花灑插座
1500mm花灑軟管



Casement 凱西蒙



§ 4,800

W3180501-TW1

單把臉盆龍頭

金屬材質把手
無鉛銅材質主體
陶瓷閥芯(φ25)
含提拉式排水組



§ 9,800

W4580501-TW1

雙把3孔分離式
臉盆龍頭

金屬材質把手
無鉛銅材質主體
90° 陶瓷閥芯
含提拉式排水組



§ 14,800

S7380501-TW1

單把3孔分離式
浴缸龍頭

金屬材質把手
銅材質主體
陶瓷平衡閥芯(φ40)
單功能手握花灑



§ 7,200

W3580501-TW4

單把高腳臉盆龍頭

金屬材質把手
無鉛銅材質主體(一體式)
陶瓷閥芯(φ25)
含銅手按式排水組



§ 7,800

W8880501-TW4

單把2孔入牆
臉盆龍頭

金屬材質把手
無鉛銅材質主體
陶瓷閥芯(φ35)
含銅手按式排水組

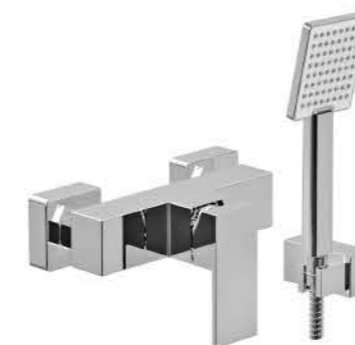

§ 6,300

S5180501-TW

單把掛牆淋浴龍頭

金屬材質把手
銅材質主體
陶瓷閥芯(φ35)
含單功能吸氣花灑, 花灑插座
1500mm花灑軟管

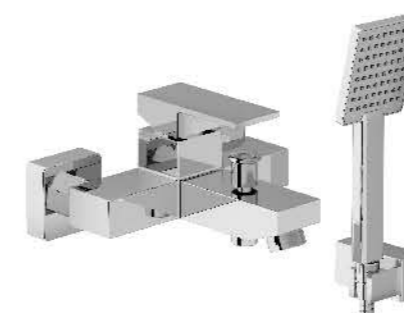

§ 8,800

S5380501-TW

單把掛牆淋浴浴缸龍頭

金屬材質把手
銅材質主體
陶瓷閥芯(φ35)
含單功能吸氣花灑, 花灑插座
1500mm花灑軟管



Portico 波帝克



§ 6,500

W3181501-TW1

單把臉盆龍頭

金屬材質把手
無鉛銅材質主體
陶瓷閥芯(Φ35)
含提拉式排水組



§ 9,600

W3581501-TW4

單把高腳臉盆龍頭

金屬材質把手
無鉛銅材質主體(一體式)
陶瓷閥芯(Φ35)
含銅手按式排水組



§ 9,600

S5381501-TW1

單把掛牆淋浴浴缸龍頭

金屬材質把手
銅材質主體
陶瓷閥芯(Φ35)
含3功能吸氣花灑, 花灑插座
1500mm花灑軟管

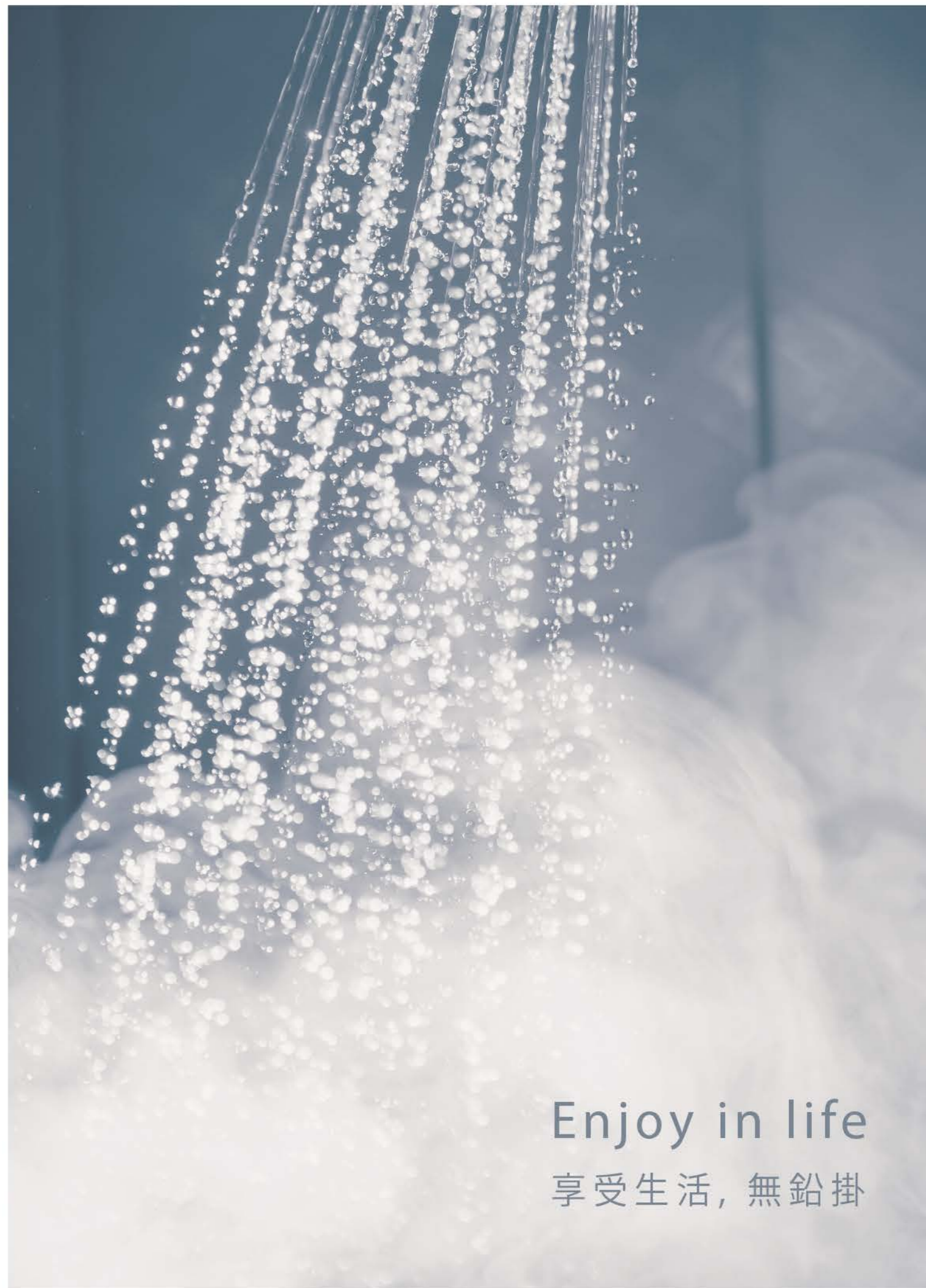

Enjoy in life
享受生活, 無鉛掛

Trim 魔方



§ 4,500

W8160801-TW1

單把臉盆龍頭

金屬材質把手
無鉛銅材質主體
陶瓷閥芯(Φ35)
含提拉式排水組



§ 5,800

W3160801-TW1

單把臉盆龍頭

金屬材質把手
無鉛銅材質主體
陶瓷閥芯(Φ35)
含提拉式排水組



§ 8,500

W3560801-TW4

單把高腳臉盆龍頭

金屬材質把手
無鉛銅材質主體
陶瓷閥芯(Φ35)
含銅手按式排水組



§ 8,800

W4560801-TW4

雙把3孔分離式
臉盆龍頭

金屬材質把手
無鉛銅材質主體
90°陶瓷閥芯
含銅手按式排水組



§ 6,800

W8160838-TW1

單把臉盆龍頭

金屬材質把手
無鉛銅材質主體
陶瓷閥芯(Φ35)
含提拉式排水組



啞光黑



§ 8,800

W3160838-TW1

單把臉盆龍頭

金屬材質把手
無鉛銅材質主體
陶瓷閥芯(Φ35)
含提拉式排水組



啞光黑

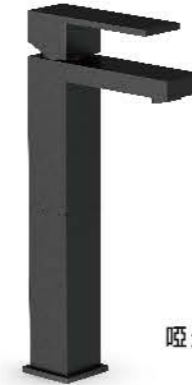

§ 11,000

W3560838-TW4

單把高腳臉盆龍頭

金屬材質把手
無鉛銅材質主體(一體式)
陶瓷閥芯(Φ35)
含銅手按式排水組



啞光黑



§ 10,800

W4560838-TW4

雙把3孔分離式
臉盆龍頭

金屬材質把手
無鉛銅材質主體
90°陶瓷閥芯
含銅手按式排水組



啞光黑



§ 12,800

S7382001-TW

雙把3孔分離式
浴缸龍頭

金屬材質把手
銅材質主體
90°陶瓷閥芯



Edin 伊登



§ 7,800

W4561201-TW1

雙把3孔分離式
臉盆龍頭

金屬材質把手
無鉛銅材質主體
90° 陶瓷閥芯
含提拉式排水組



§ 9,000

S7361201-TW

雙把3孔分離式
浴缸龍頭

金屬材質把手
銅材質主體
90° 陶瓷閥芯



§ 12,000

S7461201-TW

雙把4孔分離式
浴缸龍頭

金屬材質把手
銅材質主體
90° 陶瓷閥芯
銅材質手握花灑



Essence 伊聖斯



§ 9,800

W3160501-TW1

單把臉盆龍頭

金屬材質把手
無鉛銅材質主體
陶瓷閥芯(Φ26)
含提拉式排水組



§ 12,800

W4560501-TW1

雙把3孔分離式
臉盆龍頭

金屬材質把手
無鉛銅材質主體
90° 陶瓷閥芯
含提拉式排水組



§ 13,800

S7360501-TW1

雙把3孔分離式
浴缸龍頭

金屬材質把手
銅材質主體
90° 陶瓷閥芯



§ 15,800

S7460501-TW1

雙把4孔分離式
浴缸龍頭

金屬材質把手
90° 陶瓷閥芯
銅材質主體
塑膠手握花灑



Crisscross 酷仕

Ultra 歐賽



§ 10,800

W3180901-TW1

單把臉盆龍頭

金屬材質把手
無鉛銅材質主體
陶瓷閥芯(Φ32)
含提拉式排水組



§ 14,800

W4580901-TW1

雙把3孔分離式
臉盆龍頭

金屬材質把手
無鉛銅材質主體
90° 陶瓷閥芯
含提拉式排水組



§ 14,800

W3180902-TW1

單把臉盆龍頭

金屬材質把手
無鉛銅材質主體
陶瓷閥芯(Φ32)
含提拉式排水組



拉絲鍍PVD



§ 16,800

S7380901-TW1

雙把3孔分離式
浴缸龍頭

金屬材質把手
銅材質主體
90° 陶瓷閥芯



§ 11,800

W4560401-TW24

雙把3孔分離式
臉盆龍頭

金屬材質把手
無鉛銅材質主體
90° 陶瓷閥芯
含銅手按式排水組



§ 21,800

S7580901-TW1

雙把5孔分離式
浴缸龍頭

金屬材質把手
銅材質主體
90° 陶瓷閥芯
單功能手握花灑



§ 11,500

W4860401-TW24

雙把3孔分離式
入牆臉盆龍頭

金屬材質把手
無鉛銅材質主體
90° 陶瓷閥芯
含銅手按式排水組



§ 13,000

S5380901-TW1

單把掛牆淋浴浴缸龍頭

金屬材質把手
銅材質主體
陶瓷閥芯(Φ35)
含3功能進氣花灑, 花灑插座
1500mm花灑軟管



Vintage 干邑

¥ 18,800

W4560301-TW4

雙把3孔分離式
臉盆龍頭

銅材質把手
無鉛銅材質主體
90° 陶瓷閥芯
旋轉出水口
含銅手按式排水組



¥ 19,800

S7360301-TW

雙把3孔分離式
浴缸龍頭

銅材質把手
銅材質主體
90° 陶瓷閥芯
旋轉出水口

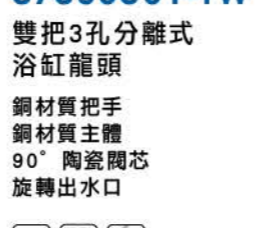

¥ 15,000

W4860301-TW4

雙把3孔分離式入牆
臉盆龍頭

銅材質把手
無鉛銅材質主體
90° 陶瓷閥芯
旋轉出水口
含銅手按式排水組



¥ 25,800

S7560301-TW

雙把5孔分離式
浴缸龍頭

銅材質把手
90° 陶瓷閥芯
銅材質主體
銅材質手握花灑
旋轉出水口

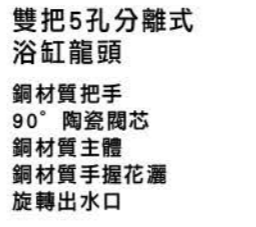

Flicker 菲利克

¥ 4,100

W3181601-TW14

單把臉盆龍頭

金屬材質把手
無鉛銅材質主體
陶瓷閥芯(Φ25)
含銅手按式排水組



¥ 8,600

W3181635-TW14

單把臉盆龍頭

金屬材質把手
無鉛銅材質主體
陶瓷閥芯(Φ25)
含銅手按式排水組



玫瑰金PVD

¥ 4,600

W8181601-TW14

單把臉盆龍頭

金屬材質把手
無鉛銅材質主體
陶瓷閥芯(Φ25)
含銅手按式排水組



¥ 9,000

W8181635-TW14

單把臉盆龍頭

金屬材質把手
無鉛銅材質主體
陶瓷閥芯(Φ25)
含銅手按式排水組



玫瑰金PVD

¥ 7,200

W3581601-TW14

單把高腳臉盆龍頭

金屬材質把手
無鉛銅材質主體(一體式)
陶瓷閥芯(Φ25)
含銅手按式排水組



¥ 12,200

W3581635-TW14

單把高腳臉盆龍頭

金屬材質把手
無鉛銅材質主體(一體式)
陶瓷閥芯(Φ25)
含銅手按式排水組



玫瑰金PVD

¥ 6,800

W3881601-TW14

單把2孔入牆臉盆龍頭

金屬材質把手
無鉛銅材質主體
陶瓷閥芯(Φ25)
含銅手按式排水組



Waterfall 瀑布



\$\$\$ 6,500

W8181701-TW4

單把臉盆龍頭

金屬材質把手
無鉛銅材質主體
瀑布出水口
陶瓷閥芯(Φ25)
含銅手按式排水組



NEW

\$\$\$ 5,500

W8180501-TW4

單把臉盆龍頭

金屬材質把手
無鉛銅材質主體
瀑布出水口
陶瓷閥芯(Φ25)
含銅手按式排水組



\$\$\$ 19,800

W3180801-TW4

單把臉盆龍頭

金屬材質把手
無鉛銅材質主體
瀑布出水口
陶瓷閥芯(Φ35)
含銅手按式排水組



\$\$\$ 7,500

W3181701-TW4

單把臉盆龍頭

金屬材質把手
無鉛銅材質主體
瀑布出水口
陶瓷閥芯(Φ25)
含銅手按式排水組



\$\$\$ 5,500

P0129401-TW

浴缸出水口

銅材質
銅材質主體
不帶提拉換向功能



\$\$\$ 22,000

W3180813-TW4

單把臉盆龍頭

金屬材質把手
無鉛銅材質主體
瀑布出水口
陶瓷閥芯(Φ35)
含銅手按式排水組



青銅PVD





廚房龍頭

◆
Kitchen
Mixer

Touch 觸控感應式廚房龍頭

Touch Faucet Products

- 觸碰感應
- 輕鬆用水
- 直覺操作

任何角度，輕鬆開水超便利

洗潔液不沾把手，享受乾淨舒適的流理舞台，讓烹飪藝術完美呈現

優雅的造型線條，來自於芭蕾舞者律動輕柔，觸控功能在不改變原有的使用習慣下，也可以輕鬆體驗方便的洗滌經驗。



單把下拉式廚房龍頭

- \$ 18,800 觸控感應 K1823501-TWSPM
- \$ 10,800 臺面安裝 K1823501-TWPM

金屬材質把手
360°旋轉出水口
無鉛銅水路
金屬材質主體
陶瓷閥芯(Φ35)
兩功能下拉式噴頭
花灑軟管快接結構



廚房龍頭出水流量

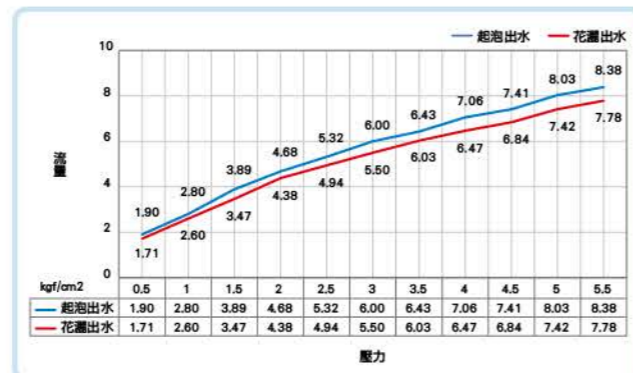

觸控原理

本產品的觸控原理是利用人體的電流感應進行工作的；連接電池盒的控制模組通過導電環與龍頭的金屬部件連接導通，形成一個電容；當人手觸摸龍頭的金屬部件時，會使原有的控制模組的電容量發生變化，通過檢測電容量的變化，控制模組會做出反應，控制電磁閥進行打開（出水）與關閉（不出水）兩種狀態的切換。

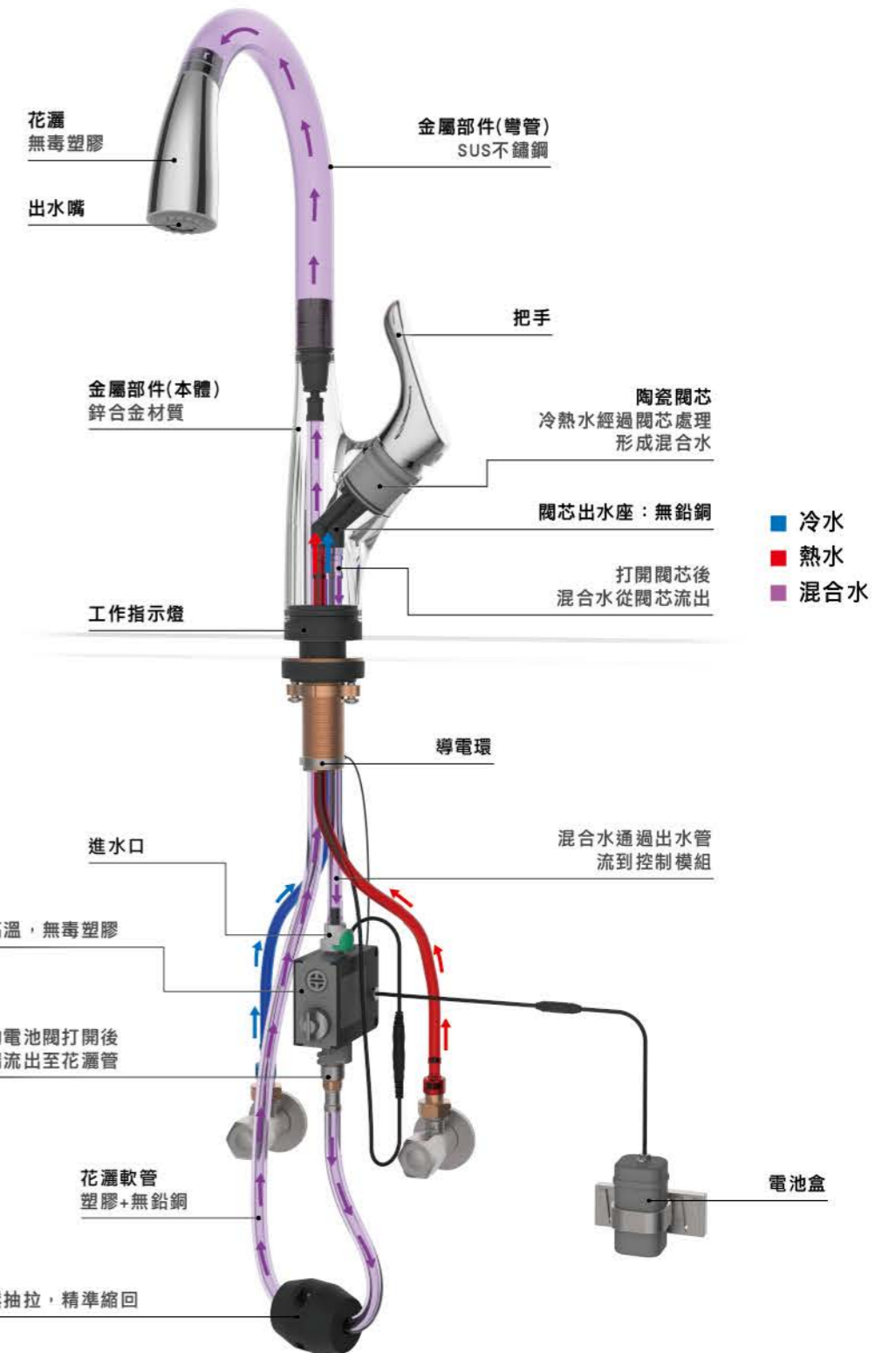

Kitchen 廚房龍頭

▶ 單把掛牆廚房龍頭



§ 3,200
K3780601-TW

金屬材質把手
360° 旋轉出水口
無鉛銅材質主體
陶瓷閥芯(Φ35)



▶ 單把廚房龍頭



§ 2,500
K1280601-TW

金屬材質把手
360° 旋轉出水口
無鉛銅材質主體
陶瓷閥芯(Φ35)



§ 3,400
K1280201-TW

金屬材質把手
360° 旋轉出水口
無鉛銅材質主體
陶瓷閥芯(Φ35)



NEW § 6,200
K1260401-TW1

金屬材質把手
360° 旋轉出水口
無鉛銅材質主體
陶瓷閥芯(Φ25)



§ 4,900
K1281501-TW

金屬材質把手
360° 旋轉出水口
無鉛銅材質主體
陶瓷閥芯(Φ35)



廚房龍頭出水流量

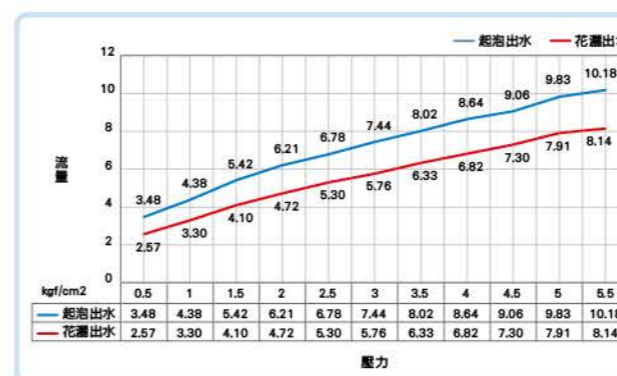
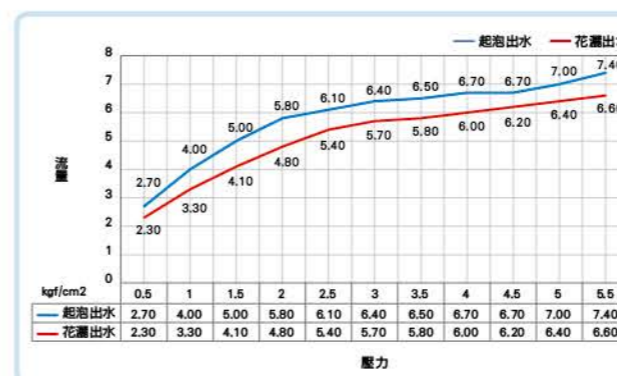
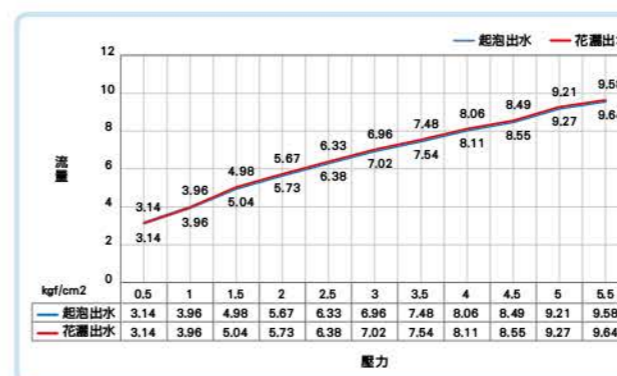

▶ 單把上拉式廚房龍頭



§ 3,800
K1680001-TWQ

金屬材質把手
90° 旋轉出水口
無鉛銅水路
金屬材質主體
90° 陶瓷閥芯(Φ35)
兩功能抽拉式噴頭



§ 4,200
K1680201-TWR

金屬材質把手
90° 旋轉出水口
無鉛銅水路
金屬材質主體
90° 陶瓷閥芯(Φ35)
兩功能抽拉式噴頭



§ 5,900
K1661201-TWS

金屬材質把手
90° 旋轉出水口
無鉛銅水路
金屬材質主體
90° 陶瓷閥芯(Φ35)
兩功能抽拉式噴頭



§ 6,800
K1623901-TWPF

金屬材質把手
90° 旋轉出水口
無鉛銅水路
金屬材質主體
90° 陶瓷閥芯(Φ35)
兩功能抽拉式噴頭





兩功能下拉式噴頭
方便操作的操作按鈕，
讓您輕鬆切換水柱型式。



手握噴頭
手握噴頭可旋轉。



金屬材質主體
方與圓的完美轉接，以簡約
的元素營造前衛的質感。

▶ 單把下拉式廚房龍頭

廚房龍頭出水流量

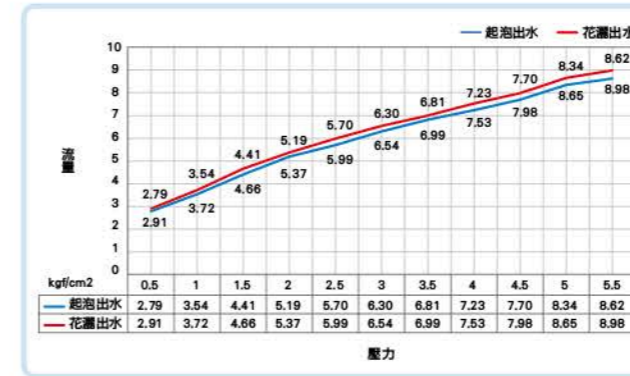

\$ 5,200

K1880201-TWC

金屬材質把手
360° 旋轉出水口
無鉛銅水路
金屬材質主體
陶瓷閥芯 (Φ 35)
兩功能下拉式噴頭

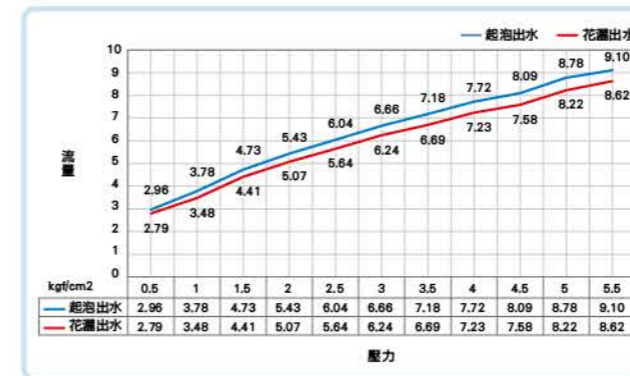

\$ 6,200

K1960701-TWMPE

金屬材質把手
360° 旋轉出水口
無鉛銅水路
金屬材質主體
陶瓷閥芯 (Φ 35)
兩功能下拉式噴頭，帶磁吸效果

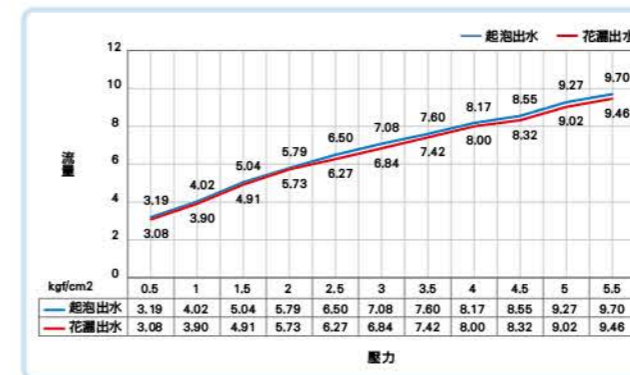
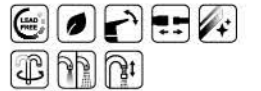

\$ 7,200

K1802101-TWMJ

金屬材質把手
360° 旋轉出水口
無鉛銅水路
金屬材質主體
陶瓷閥芯 (Φ 35)
兩功能下拉式噴頭，帶磁吸效果

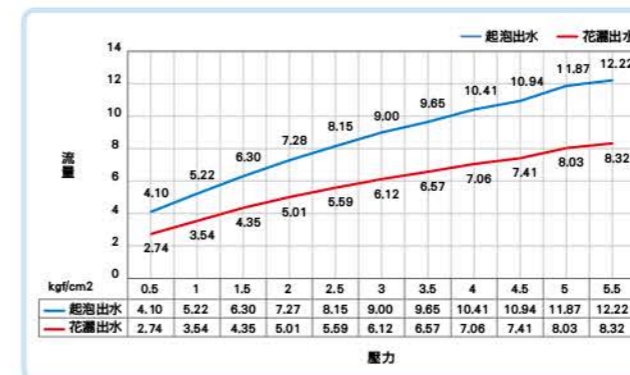

\$ 7,700

K1902101-TWMP

金屬材質把手
360° 旋轉出水口
無鉛銅水路
金屬材質主體
陶瓷閥芯 (Φ 35)
兩功能下拉式噴頭，帶磁吸效果





兩功能下拉式噴頭

花灑頭操作簡易，僅以您的指尖及可控制出水型式，符合您的需求。

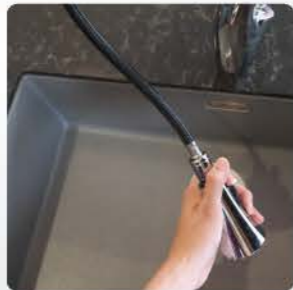

彈簧管

靈活性佳的彈簧管，提供給您操作最優的自由度。



金屬材質主體

細緻而如羽片般的金屬把手，伴隨樂趣的使用手感；造型上的設計使您生活更貼近藝術賞完之意味。

單把下拉式廚房龍頭

廚房龍頭出水流量

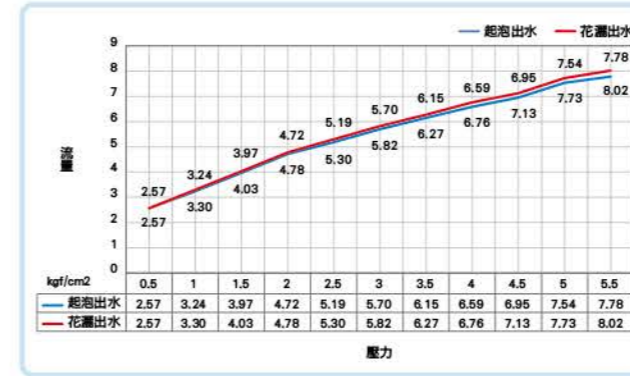

U \$ 6,800
K1811001-TWMD

金屬材質把手
360° 旋轉出水口
無鉛銅水路
金屬材質主體
陶瓷閥芯(Φ35)
兩功能下拉式噴頭，帶磁吸效果

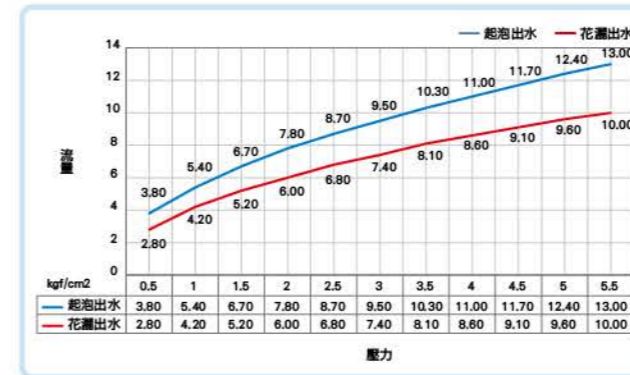
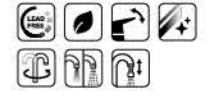

U \$ 6,800
K1824301-TWMPQ

金屬材質把手
360° 旋轉出水口
無鉛銅水路
金屬材質主體
陶瓷閥芯(Φ35)
兩功能下拉式噴頭，帶磁吸效果

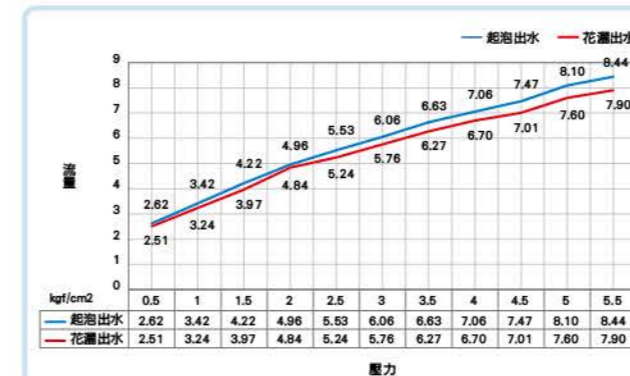

\$ 7,800
K1822330-TWPD

金屬材質把手
360° 旋轉出水口
無鉛銅水路
金屬材質主體
陶瓷閥芯(Φ25)
兩功能下拉式噴頭

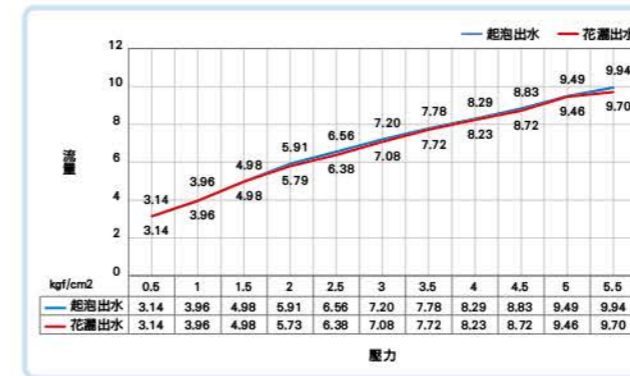

U \$ 12,800
K1822401-TWMPG

金屬材質把手
360° 旋轉出水口
無鉛銅水路
金屬材質主體
陶瓷閥芯(Φ25)
兩功能下拉式噴頭，帶磁吸效果





此廚房龍頭提供您，專業又實用的廚房使用體驗，讓您沉浸於烹調的樂趣中。



兩功能下拉式噴頭

花灑頭操作簡易，僅以您的指尖及可控制出水型式，符合您的需求。



彈簧管

靈活性佳的彈簧管，提供給您操作最優的自由度。



金屬材質主體

以曲線勾勒出優雅的瓶身本體，跟您的廚房形成更時尚的融合。

多色選擇，簡易換色，增添廚房好心情！
花灑軟管快接結構，防卡垢好清潔，無菌更清新！

NEW

均可自行更換顏色



花灑軟管快接結構

單把下拉式廚房龍頭

廚房龍頭出水流量

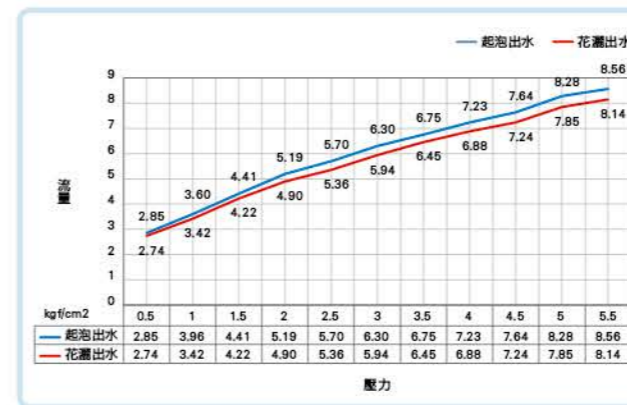

無矽膠管款式

\$ 7,800 ● K1822601-TWPE

\$ 8,500 ● K1822601-TWPE2

● K1822601-TWPE4

● K1822601-TWPE6

● K1822601-TWPE8

金屬材質把手
360度旋轉出水口
無鉛銅水路
金屬材質主體
陶瓷閥芯(Φ25)
兩功能下拉式噴頭

● 無矽膠軟管 ● 四色矽膠管



不鏽鋼 / 浴室龍頭

SUS 304



\$ 3,200

W3124642-TW

單把臉盆龍頭

SUS304材質把手
SUS304材質主體
陶瓷閥芯(Φ35)



不銹鋼拉絲

不鏽鋼 / 廚房龍頭

SUS 304



\$ 4,800

K1224742-TW

單把廚房龍頭

SUS304材質把手
SUS304材質主體
陶瓷閥芯(Φ35)
360°旋轉折疊出水口



不銹鋼拉絲



\$ 7,200

K1224942-TW

單把三用式廚房龍頭

SUS304材質把手
SUS304材質主體
陶瓷閥芯(Φ35)
帶純淨水切換功能
360°旋轉出水口



不銹鋼拉絲



\$ 6,200

K1224642-TW

單把三用式廚房龍頭

SUS304材質把手
SUS304材質主體
陶瓷閥芯(Φ35)
帶純淨水切換功能
360°旋轉出水口



不銹鋼拉絲



\$ 1,700

K1124742-TW

單把純淨水龍頭

SUS304材質把手
SUS304材質主體
90°陶瓷閥芯
360°旋轉出水口



不銹鋼拉絲

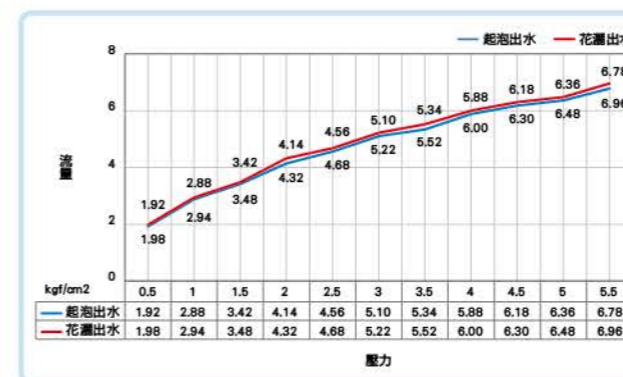

\$ 8,800

K1824642-TW

單把下拉式廚房龍頭

SUS304材質把手
SUS304材質主體
陶瓷閥芯(Φ35)
兩功能下拉式噴頭
360°旋轉出水口



不銹鋼拉絲

Bathroom 單把掛牆淋浴、浴缸雙花灑產品

▶ 單把掛牆-淋浴雙花灑龍頭

金屬材質把手
銅材質主體
陶瓷閥芯(φ35)
SUS304材質升降桿
8"單功能太陽花灑
單功能手握花灑
1500mm花灑軟管



樂活

\$ 7,800

S5780101-TW



凱西蒙

\$ 10,500

S5780501-TW



▶ 掛牆恒溫-淋浴浴缸雙花灑龍頭



金屬材質把手
銅材質主體
旋轉出水口
SUS304升降桿組
左把手調節溫度
右把手調節流量以及開關出水
Vernet恆溫芯棒
含單功能手握花灑
1500mm花灑軟管
8"單功能太陽花灑



普萊斯

\$ 14,500

S5902401-TW



▶ 單把掛牆-淋浴浴缸雙花灑龍頭

金屬材質把手
銅材質主體
SUS304材質升降桿
陶瓷閥芯(φ35)
含三功能手握花灑, 花灑插座
1500mm花灑軟管
8"單功能太陽花灑
旋轉出水口



星動

\$ 10,000

S5980201-TW



▶ 雙花灑升降杆組

SUS304材質升降桿(含花灑插座)
8"單功能太陽花灑
含鏈接軟管
不含手握花灑和花灑軟管



星動

\$ 6,000

P0134101-TW1



凱西蒙

\$ 9,000

P0234101-TW1



爵士 - 掛牆淋浴、浴缸置物盒產品

Jazz - Wall Mounted Shower-Bath Storage Box Products

- 智慧恆溫
- 防燙設計
- 直覺操作
- 快速拆裝
- 置物設計

NEW 造型簡潔高雅大方
淋浴系統完美整合



擁有置物功能，沐浴好便利



浴缸出水口
可360°旋轉



輕鬆轉動切換出水方式

左側單邊轉動控制水溫
轉動 控制出水開關

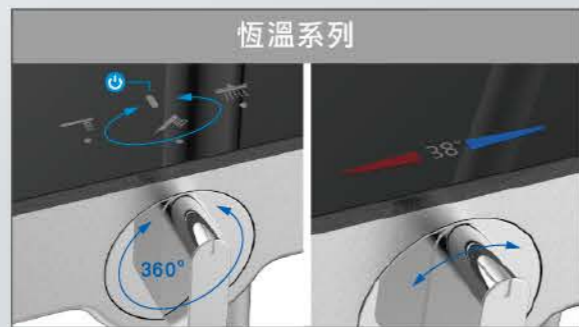

360° 輕鬆轉動切換出水方式
轉動 控制出水開關

恆溫38° 安全防燙
調整所需的溫度

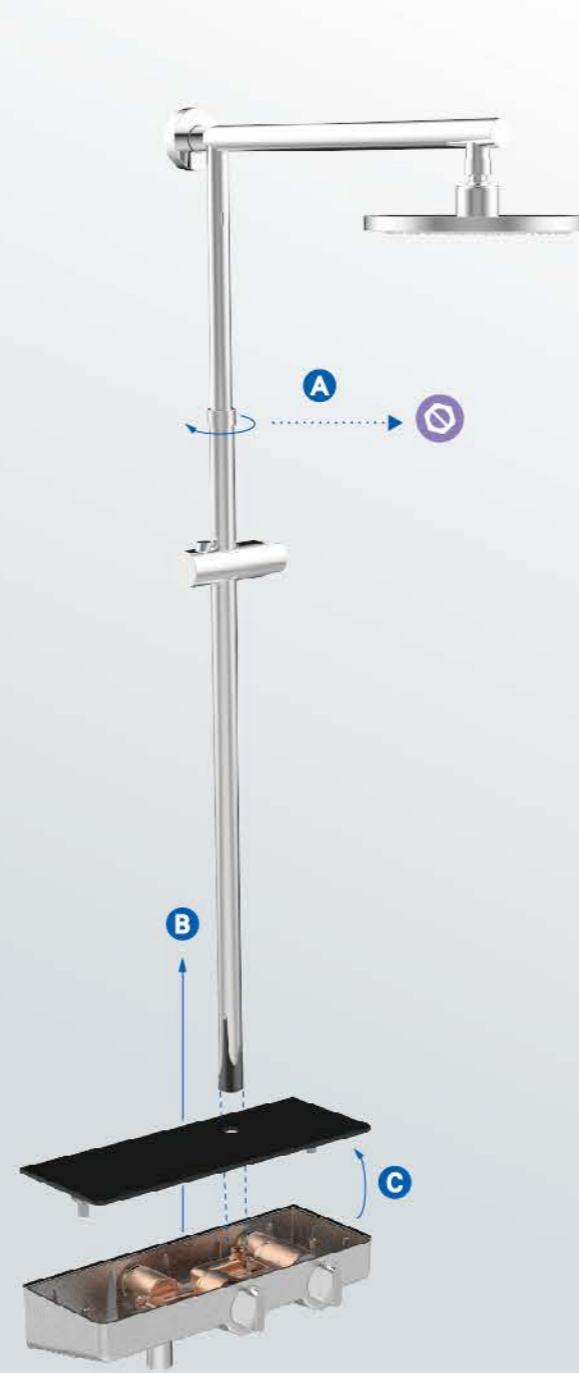

快速拆裝

專利原裝研發安裝結構
產品安裝，維護變得簡單易行
全銅閥體製造，彰顯超強品質

快速拆裝 3 步驟

- A 轉鬆頂噴硬管
- B 將頂噴硬管往上抽
- C 拆卸面蓋，進行過濾網清洗或置換

快速拆裝

Thermostatic
恆溫專屬

過濾網
全銅閥體製造

專利獨創上清洗濾網結構
濾網清潔不費周章



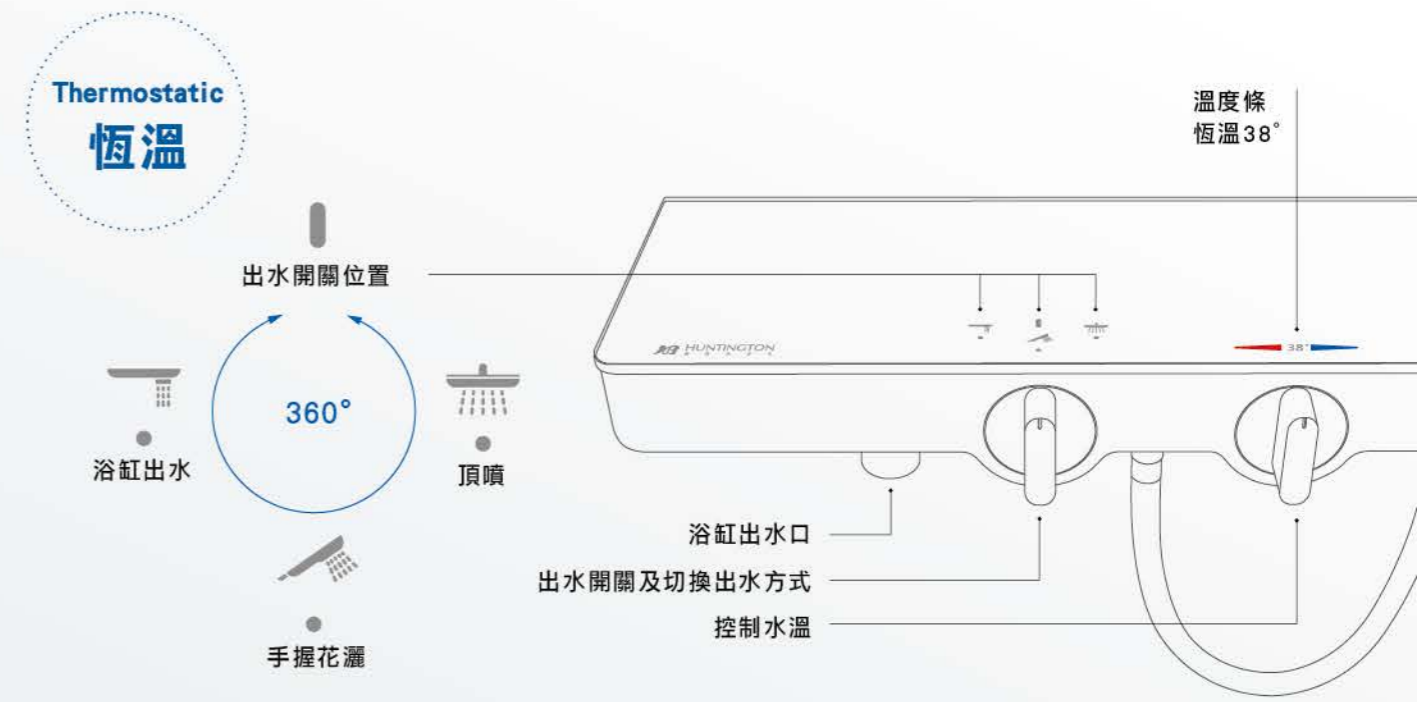
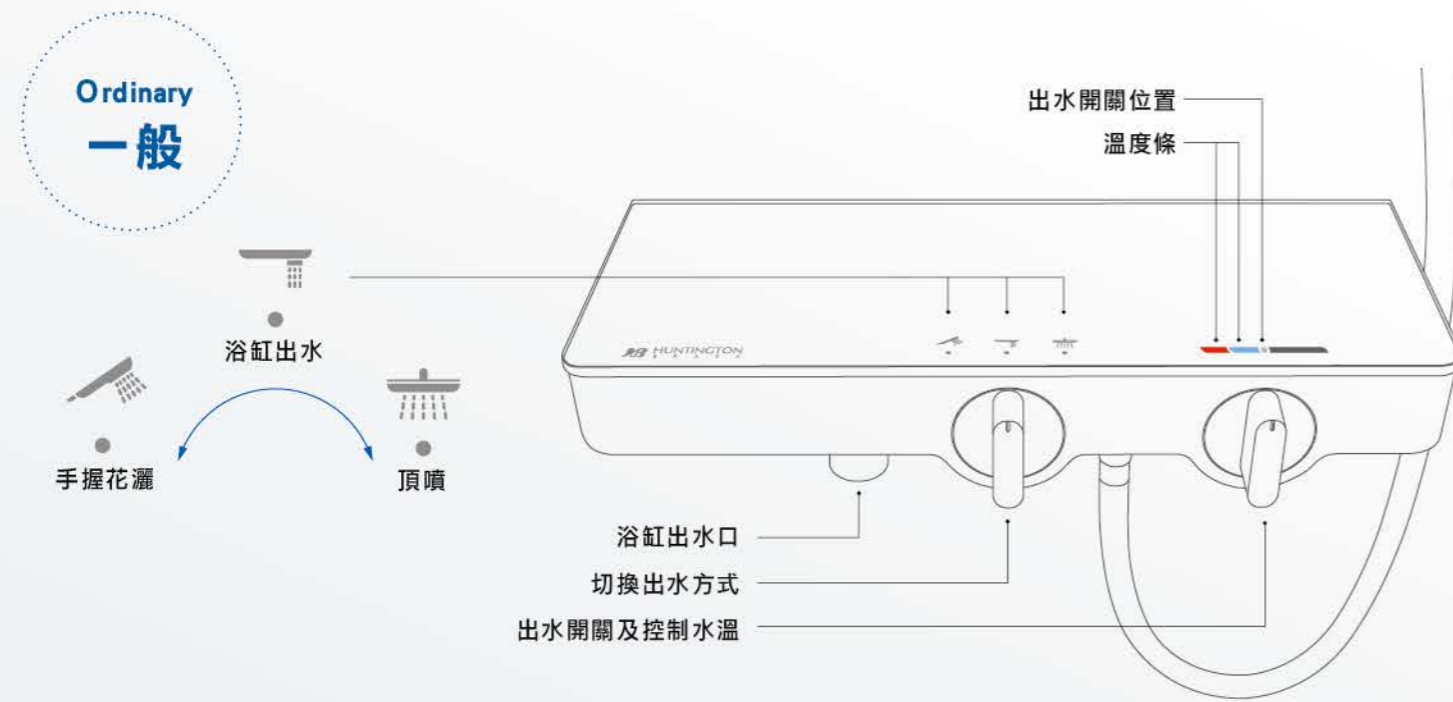

§ 9,800

S5328901-TW

掛牆淋浴浴缸
單花灑置物盒龍頭

鋼化玻璃置物板
金屬把手，銅本體
旋轉浴缸出水
陶瓷閥芯(φ35)
雙功能手握花灑
銀色PVC花灑軟管



§ 12,800

S5129001-TW

掛牆恆溫淋浴
單花灑置物盒龍頭

鋼化玻璃置物板
金屬把手，銅本體
旋轉式切換
恆溫閥芯(德國Vnet)
雙功能手握花灑
銀色PVC花灑軟管
免拆裝龍頭即可沖洗
更換濾網以及清洗濾網



§ 14,800

S5329001-TW

掛牆恆溫淋浴浴缸
單花灑置物盒龍頭

鋼化玻璃置物板
金屬把手，銅本體
旋轉浴缸出水
旋轉式切換
恆溫閥芯(德國Vnet)
雙功能手握花灑
銀色PVC花灑軟管
免拆裝龍頭即可沖洗
更換濾網以及清洗濾網



§ 12,800

S5528901-TW

掛牆淋浴
雙花灑置物盒龍頭

鋼化玻璃置物板
金屬把手，銅本體
陶瓷閥芯(φ35)
SUS304電鍍升降桿
單功能頂噴(鍍鉻面蓋)
雙功能手握花灑
銀色PVC花灑軟管



§ 14,800

S5728901-TW

掛牆淋浴浴缸
雙花灑置物盒龍頭

鋼化玻璃置物板
金屬把手，銅本體
旋轉浴缸出水
陶瓷閥芯(φ35)
SUS304電鍍升降桿
單功能頂噴(鍍鉻面蓋)
雙功能手握花灑
銀色PVC花灑軟管



§ 15,800

S5529001-TW

掛牆恆溫淋浴
雙花灑置物盒龍頭

鋼化玻璃置物板
金屬把手，銅本體
旋轉式切換
恆溫閥芯(德國Vnet)
SUS304電鍍升降桿
單功能頂噴(鍍鉻面蓋)
雙功能手握花灑
銀色PVC花灑軟管
免拆裝龍頭即可沖洗
更換濾網以及清洗濾網



§ 17,800

S5729001-TW

掛牆恆溫淋浴浴缸
雙花灑置物盒龍頭

鋼化玻璃置物板
金屬把手，銅本體
旋轉浴缸出水
旋轉式切換
恆溫閥芯(德國Vnet)
SUS304電鍍升降桿
單功能頂噴(鍍鉻面蓋)
雙功能手握花灑
銀色PVC花灑軟管
免拆裝龍頭即可沖洗
更換濾網以及清洗濾網

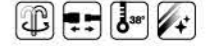



入牆淋浴系列組合

◆
**In-Wall
Shower
Series**

Splice 普萊斯



§ 2,400

1 頂噴
P2235301-TW
銅材質花灑壁管·孔罩
10"雙功能太陽花灑



§ 5,000

2 單出水面板閥體組
P0561301-TW
金屬材質把手
塑料面板
陶瓷閥芯(Φ40)
銅材質主體(單出水)



§ 5,700

3 雙出水面板閥體組
P0561301-TW1
金屬材質把手
塑料面板
陶瓷閥芯(Φ40)
銅材質主體(雙出水)



§ 7,000

4 上按壓雙出水面板閥體組
P0362301-TW
金屬材質把手
塑料面板
陶瓷閥芯(Φ40)
銅材質主體(雙出水)
按壓式換向閥



§ 1,930

5 花灑組
P0936301-TW
銅材質出水接頭(帶插座)
1500mm花灑軟管
兩功能手握花灑



§ 2,400

6 升降桿花灑組
P0836301-TW
不銹鋼升降桿
銅材質出水接頭
1500mm花灑軟管
兩功能手握花灑



§ 600

7 出水口
P0529501-TW
鋅合金材質
不帶提拉換向功能



§ 750

8 提拉式出水口
P0229501-TW
鋅合金材質
帶提拉換向功能

- S6181301-TW10 **A** ①頂噴 ②單出水面板
- S6381301-TW11 **B** ①頂噴 ④上按壓雙出水面板 ⑦出水口
- S6381301-TW10 **C** ①頂噴 ③雙出水面板 ⑧提拉式出水口
- S6581301-TW10 **D** ①頂噴 ④上按壓雙出水面板 ⑤花灑組
- S6581301-TW11 **E** ①頂噴 ④上按壓雙出水面板 ⑥升降桿花灑組
- S6181301-TW11 **F** ②單出水面板 ⑤花灑組
- S6181301-TW12 **G** ②單出水面板 ⑥升降桿花灑組

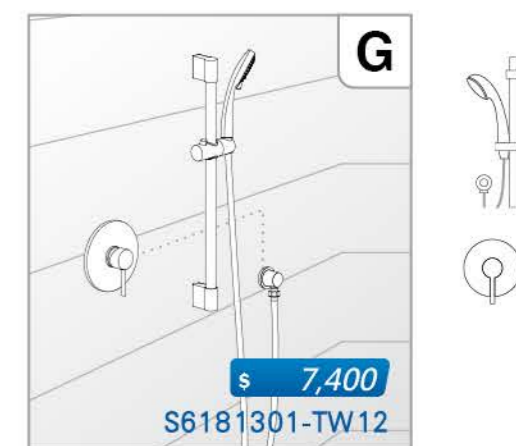
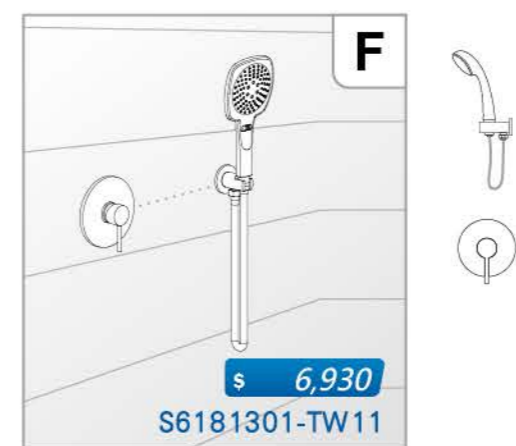
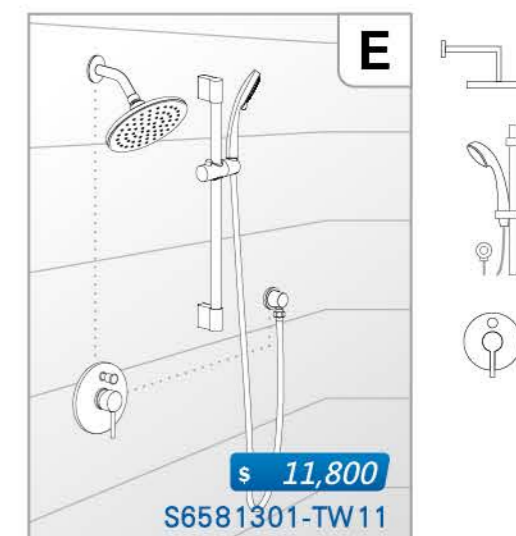
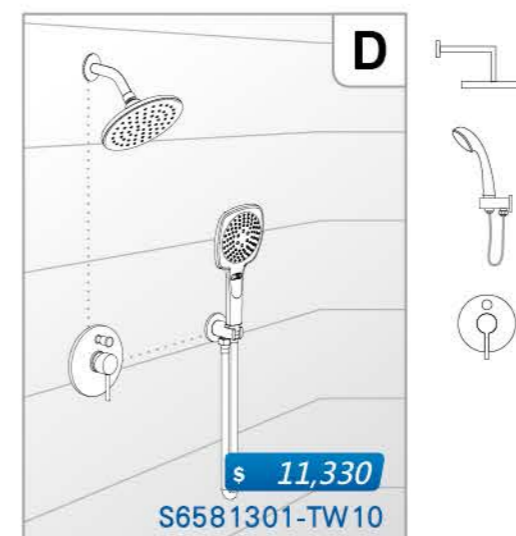
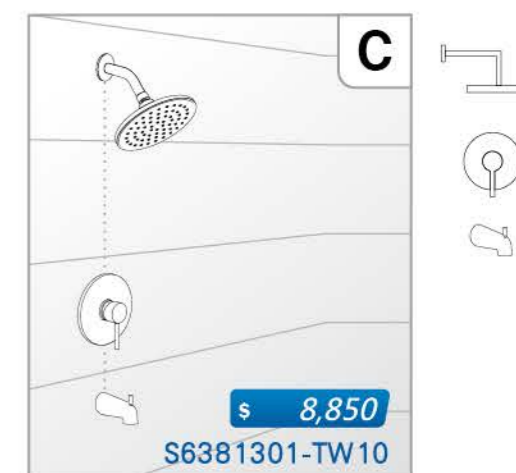
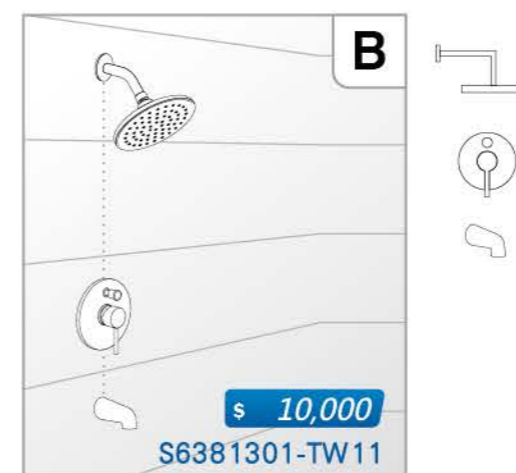
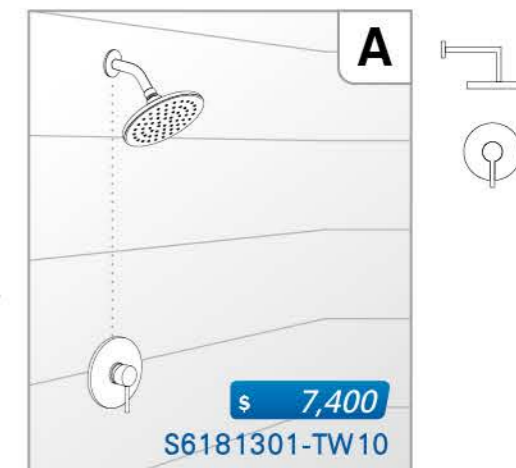

Casement 凱西蒙



§ 1,530

1 頂噴
P2135301-TW
不銹鋼花灑壁管，孔罩
6"單功能花灑



§ 8,000

2 雙出水面板閥體組
P1161101-TWB
金屬材質把手
銅材質面板
陶瓷壓力平衡閥芯(Φ40)
銅材質主體(雙出水)



§ 9,000

3 上按壓雙出水面板閥體組
P0962101-TWB
金屬材質把手
銅材質面板
陶瓷壓力平衡閥芯(Φ40)
銅材質主體(雙出水)
按壓式換向閥



§ 1,700

4 花灑組
P1136301-TW
銅材質出水接頭(帶插座)
1500mm花灑軟管
3功能手握花灑



§ 2,800

5 升降桿花灑
P1036301-TW
不銹鋼升降桿
銅材質出水接頭
1500mm花灑軟管
3功能手握花灑



§ 1,000

6 出水口
P0929501-TW
鋅合金材質
不帶提拉換向功能



§ 1,200

7 提拉式出水口
P0829501-TW
鋅合金材質
帶提拉換向功能

- S6180501-TWB10 **A** ①頂噴 ②雙出水面板
- S6380501-TWB11 **B** ①頂噴 ③上按壓雙出水面板 ⑥出水口
- S6380501-TWB10 **C** ①頂噴 ②雙出水面板 ⑦提拉式出水口
- S6580501-TWB10 **D** ①頂噴 ③上按壓雙出水面板 ④花灑組
- S6580501-TWB11 **E** ①頂噴 ③上按壓雙出水面板 ⑤升降桿花灑組
- S6180501-TWB11 **F** ②雙出水面板 ④花灑組
- S6180501-TWB12 **G** ②雙出水面板 ⑤升降桿花灑組

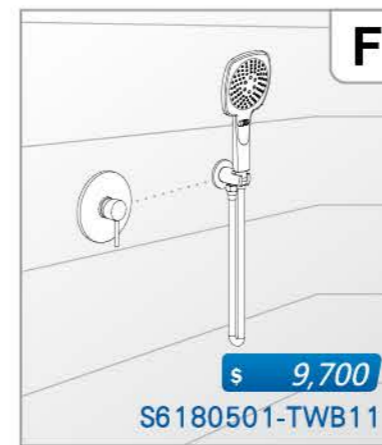
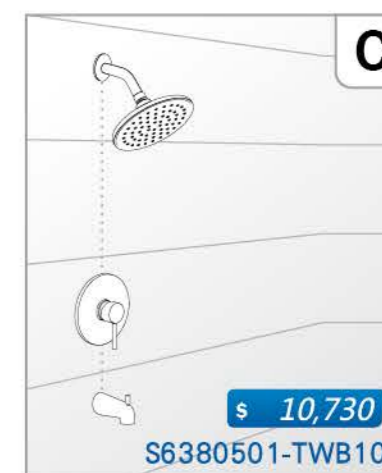
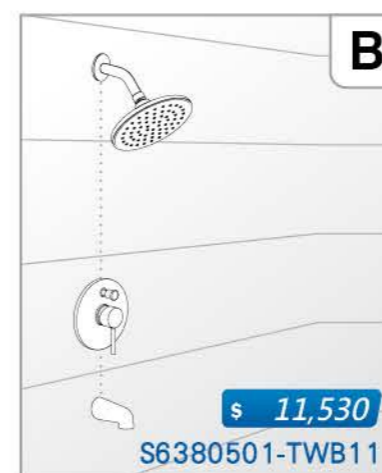
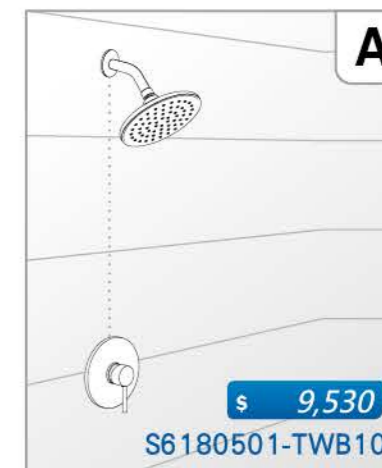

Bathroom 入牆壓力平衡閥本體組

In-Wall Pressure Balance Valves



入牆浴缸&淋浴本體組
P03231XX-TW



入牆淋浴本體組
P02231XX-TW

大流量壓力平衡閥

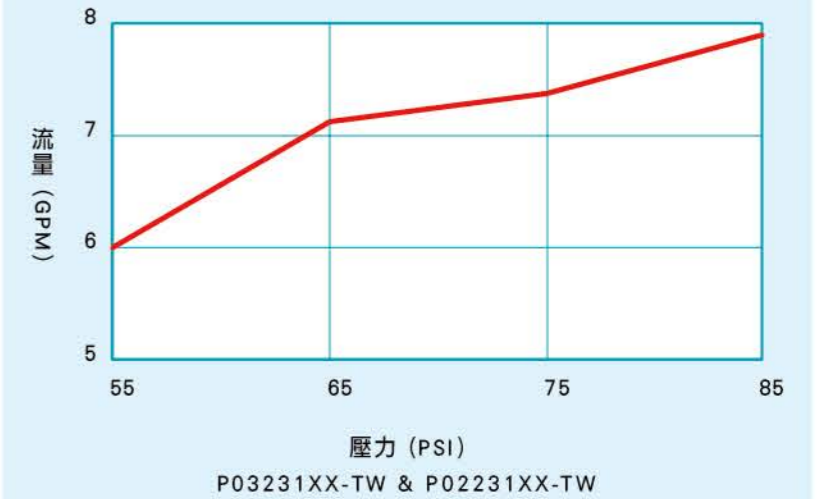

★ 閥芯五年保固。
大流量的設計使龍頭即使在低水壓條件下仍具有卓越的性能。

按壓換向閥介紹：

- 換向閥通過下按換向，從浴缸出水切換至花灑出水，操作方便。
- 關閉閥芯後自動復位，避免來回手動切換的麻煩。



1/2" 標準接頭

銅鍛造本體

按壓換向閥

流量控制式
壓力平衡閥芯

閥芯溫度調節環

止逆閥 (止水和防逆流功能)

Portico 波帝克



§ 2,800

1 頂噴壁管組
P2435301-TW
銅材質花灑壁管，孔罩
8"單功能太陽花灑



§ 18,000

2 頂噴
P2227401-TW
SUS304不銹鋼材質
兩功能
帶瀑布出水



§ 900

3 噴頭
P0146101-TW
銅旋轉噴頭
不銹鋼裝飾蓋



§ 18,000

4 恆溫面板閥體組
P2262101-TWS
金屬材質把手
3mm銅面板
恆溫閥芯
銅材質主體
帶3通分水器



§ 1,950

5 插座花灑組
P1136301-TW
銅材質出水接頭
1500mm銀色PVC花灑軟管
三功能手握花灑

S6581501-TWS10 **A** ①頂噴臂管組 ④恆溫面板 ⑤插座花灑組

S6181501-TWS11 **B** ②頂噴 ④恆溫面板

S6581501-TWS12 **C** ②頂噴 ④恆溫面板 ⑤插座花灑組

S6681501-TWS10 **D** ②頂噴 ③噴頭x6 ④恆溫面板

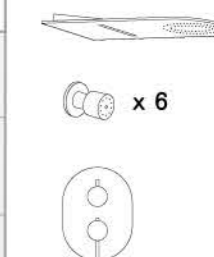
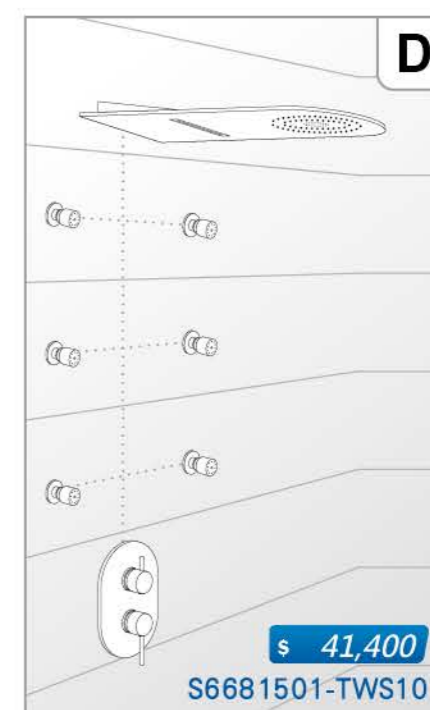
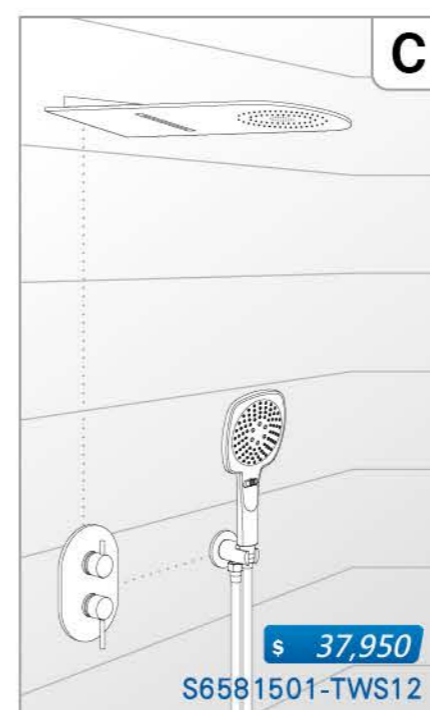
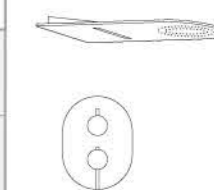
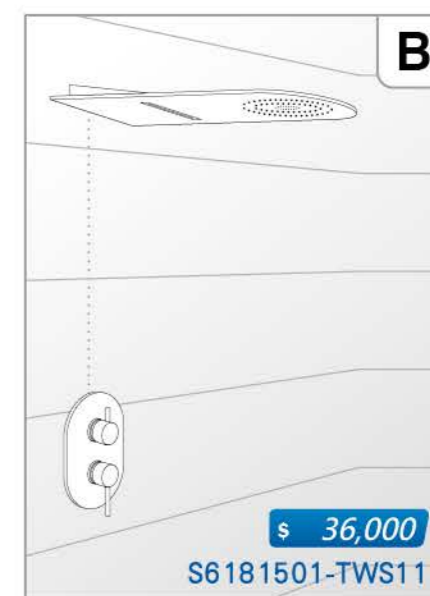
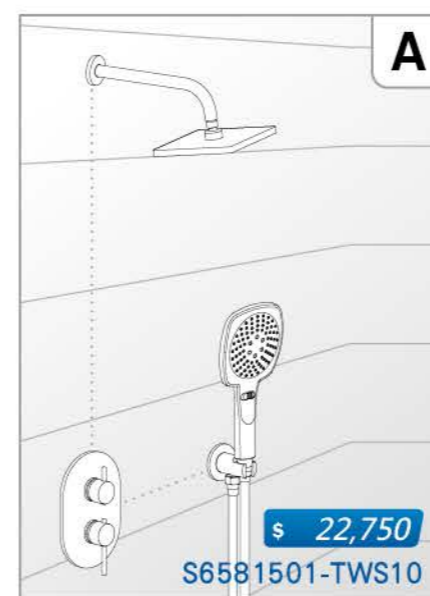

Bathroom 單把落地浴缸龍頭



星動

§ 18,000

S7660701-TW

金屬材質把手
銅材質主體
陶瓷閥芯(Φ35)
塑膠手握花灑
1500mm花灑軟管



普萊斯

§ 28,000

S7881301-TW

金屬材質把手
銅材質主體
陶瓷閥芯(Φ45)
塑膠手握花灑
1500mm花灑軟管



魔方

§ 30,000

S7880501-TW

金屬材質把手
銅材質主體
陶瓷閥芯(Φ35)
塑膠手握花灑
1500mm花灑軟管



歐賽

§ 32,000

S7860401-TW1

金屬材質把手
銅材質主體
陶瓷閥芯(Φ35)
塑膠手握花灑
1500mm花灑軟管



Enjoy life,
everything is up to you.





浴室配件



**Bathroom
Accessories**

Casement 凱西蒙



\$ 1,300
Y1180501-TW1
 單毛巾桿
 鋅合金材質主體

↔ 82 ↔ 650 ↓ 46



\$ 440
Y1780501-TW1
 單掛衣鉤
 鋅合金材質主體

↔ 50 ↔ 46 ↓ 46



\$ 2,300
Y1280501-TW
 雙毛巾桿
 銅材質主體

↔ 136 ↔ 646 ↓ 46



\$ 750
Y2380501-TW1
 紙巾架
 鋅合金材質主體
 含紙巾蓋

↔ 66 ↔ 138 ↓ 140

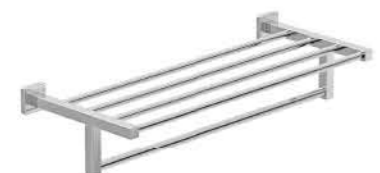

\$ 5,000
Y1380501-TW
 雙層毛巾桿
 銅材質主體

↔ 245 ↔ 606 ↓ 123



\$ 1,200
Y2780501-TW
 馬桶刷架連刷
 銅材質主體
 玻璃馬桶杯

↔ 142 ↔ 140 ↓ 356



\$ 800
Y1480501-TW1
 毛巾環
 鋅合金材質主體

↔ 66 ↔ 191 ↓ 159

Rotunda 星動



\$ 1,200
Y1180201-TW1
 單毛巾桿
 鋅合金材質主體

↔ 83 ↔ 648 ↓ 48



\$ 300
Y1780201-TW
 單掛衣鉤
 鋅合金材質主體

↔ 50 ∅ 48



\$ 2,200
Y1280201-TW
 雙毛巾桿
 銅材質主體

↔ 138 ↔ 648 ↓ 48



\$ 500
Y1880201-TW
 雙掛衣鉤
 鋅合金材質主體

↔ 55 ∅ 48

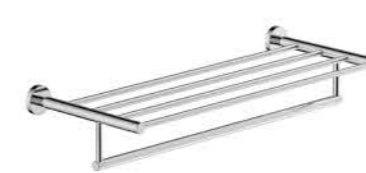

\$ 3,800
Y1380201-TW
 雙層毛巾桿
 銅材質主體

↔ 244 ↔ 608 ↓ 112



\$ 1,000
Y2380201-TW1
 紙巾架
 鋅合金材質主體
 含紙巾蓋

↔ 71 ↔ 138 ↓ 140



\$ 600
Y1480201-TW1
 毛巾環
 銅材質主體

↔ 67 ↔ 152 ↓ 171



\$ 1,200
Y2780201-TW
 馬桶刷架連刷
 銅材質主體
 玻璃馬桶杯

↔ 142 ↔ 140 ↓ 356

Vintage 干邑



\$ 2,200

Y1160301-TW

單毛巾桿

全鋼材質

↳ 89 ↔ 821 ↓ 57



\$ 1,250

Y1460301-TW

毛巾環

全鋼材質

↳ 89 ↔ 160 ↓ 179



\$ 1,000

Y1760301-TW

單掛衣鉤

全鋼材質

↳ 89 ∅ 57 ↓ 82



\$ 1,300

Y2360301-TW

紙巾架

全鋼材質

↳ 90 ↔ 150 ↓ 115

Edin 伊登



\$ 1,500

Y1161201-TW

單毛巾桿

鋅合金材質主體

↳ 93 ↔ 654 ↓ 49



\$ 820

Y1461201-TW

毛巾環

鋅合金材質主體

↳ 93 ↔ 227 ↓ 148



\$ 540

Y1761201-TW

單掛衣鉤

鋅合金材質主體

↳ 93 ∅ 49 ↓ 80



\$ 1,200

Y2361201-TW1

紙巾架

鋅合金材質主體

含紙巾蓋

↳ 94 ↔ 187 ↓ 150

Sophis 蘇菲



\$ 1,600

Y1180401-TW

單毛巾桿

鋅合金材質主體

↳ 77 ↔ 623 ↓ 30



\$ 850

Y1480401-TW

毛巾桿

鋅合金材質主體

↳ 77 ↔ 287 ↓ 30



\$ 250

Y1780401-TW

單掛衣鉤

鋅合金材質主體

↳ 40 ↔ 30 ↓ 62



\$ 1,450

Y2380401-TW

紙巾架

鋅合金材質主體

↳ 125 ↔ 156 ↓ 90



\$ 720

Y2780401-TW

馬桶刷架連刷

鋅合金材質主體

玻璃馬桶刷杯

↳ 124 ↔ 114 ↓ 356

Rondo 蘭朵



\$ 800
Y1120101-TW
 單毛巾桿
 鋅合金材質主體
 ↳ 80 ↔ 650 ↓ 50



\$ 600
Y1420101-TW
 毛巾環
 鋅合金材質主體
 ↳ 80 ↔ 152 ↓ 173



\$ 350
Y1720101-TW
 單掛衣鉤
 鋅合金材質主體
 ↳ 80 ∅ 50 ↓ 55



\$ 900
Y2320101-TW1
 紙巾架
 鋅合金材質主體
 含紙巾蓋
 ↳ 80 ↔ 133 ↓ 106



\$ 820
Y2720101-TW
 馬桶刷架連刷
 鋅合金材質主體
 玻璃馬桶刷杯
 ↳ 127 ↔ 167 ↓ 354

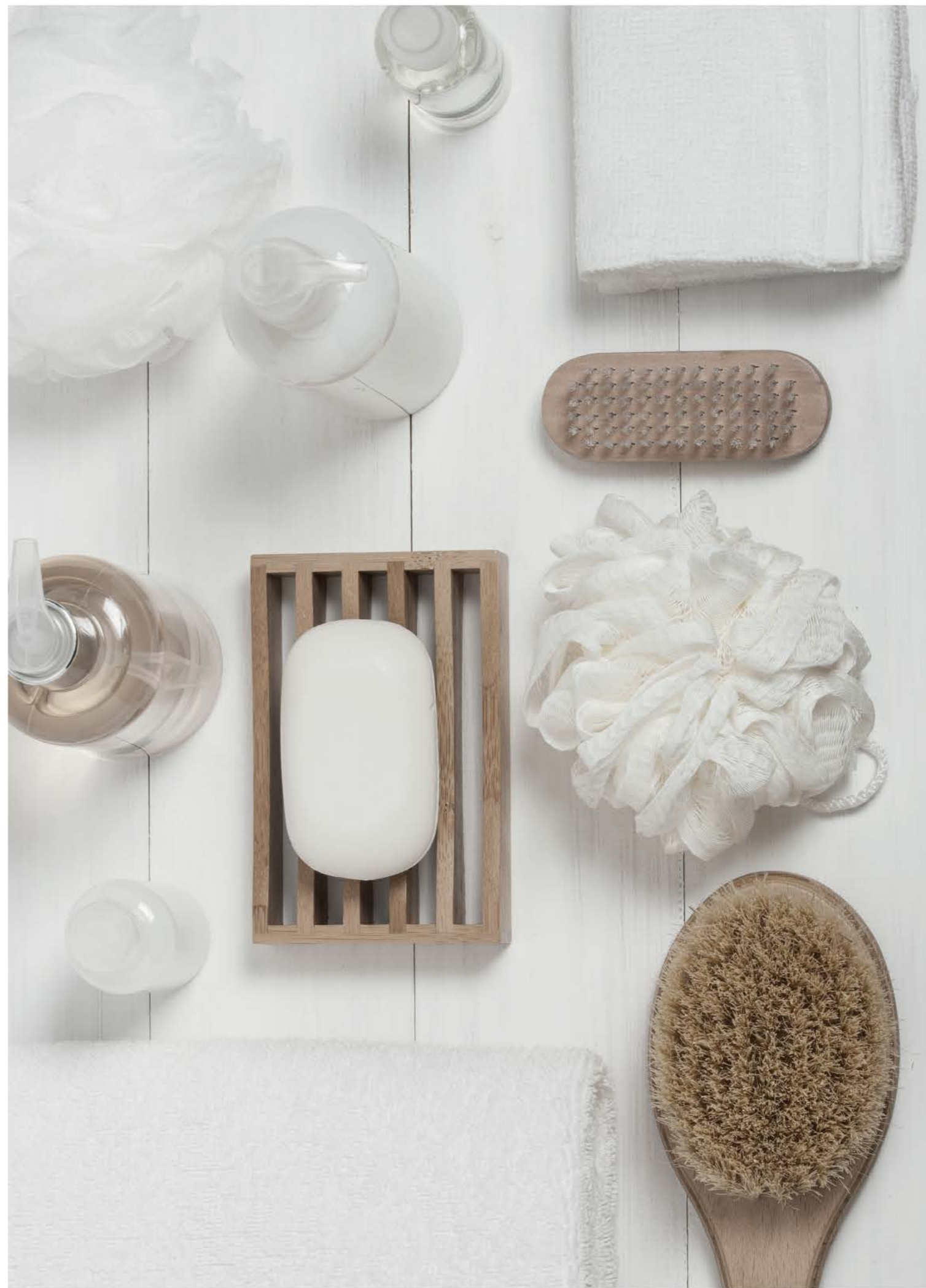



淋浴配件



**Shower
Accessories**

排水組、排水管 Fitting or Drain Assemblies

▶ 提拉式銅排桿



§ 600
P0111101-TW

銅材質主體
銅加長管
帶提拉桿
帶溢水功能



§ 600
P0111101-TW1

銅材質主體
銅加長管
帶提拉桿 (長380mm)
帶溢水功能



▶ 美式半銅塑排桿



§ 580
P0111201-TW

銅材質主體
塑膠加長管
帶提拉桿
帶溢水功能



▶ 美式塑膠排桿



§ 550
P0111301-TW

塑膠主體
塑膠加長管
帶提拉桿
帶溢水功能



▶ 手按式排水組



§ 630
P0612101-TW

銅材質
帶溢水功能



§ 630
P0112101-TW

金屬材質主體
帶溢水功能
銅材質加長管



§ 730
P0112101-TW1

金屬材質主體
帶溢水功能
銅材質加長管



§ 550
P0211101-TW

金屬材質主體
帶溢水功能
帶提拉桿



§ 500
P0211301-TW

塑膠材質主體
帶溢水功能
帶提拉桿



▶ P型排水組



§ 600
P0444401-TW

SUS304不銹鋼材質

↔315 ↓137



§ 700
P0444101-TW

銅材質

↔307 ↓137



▶ S型排水彎管



§ 850
P0144401-TW

不銹鋼管
銅螺母

↔214 ↓596



▶ 樽型排水管



§ 1,100
P0344401-TW

不銹鋼管
銅螺母

↔264 ↓183



Wall Bar 升降桿



§ 700
P0430401-TW

不銹鋼材質

↔65 ↔115 ↓656



§ 790
P0230401-TW

塑膠安裝座
不銹鋼升降桿
塑膠花灑插座

↔66 ↔116 ↓600



§ 1,075
P0130401-TW

不銹鋼材質

↔75 ↔123 ↓600



淋浴間配件 Shower & Bath Accessories

▶ 花灑插座



\$ 250

P0232301-TW

塑膠材質

↔ 79 ↑ 97 ∅ 46



\$ 300

P0332301-TW

塑膠材質

↔ 68 ↔ 88 ↓ 42



\$ 730

P0132101-TW銅接頭
銅裝飾蓋

↔ 64 ∅ 60



\$ 800

P0232101-TW銅接頭
銅裝飾蓋

↔ 71 ↔ 45 ↑ 45



\$ 150

P0532301-TW

塑膠材質

↔ 65 ↔ 41 ↑ 61



▶ 出水接頭



\$ 660

P0333101-TW銅接頭
銅裝飾蓋

↔ 45 ∅ 53



\$ 800

P0433101-TW銅接頭
銅裝飾蓋

↔ 48 ↔ 54 ↑ 54



▶ 噴頭



\$ 1,100

P0246101-TW銅旋轉噴頭
不銹鋼裝飾蓋

↔ 70 ↔ 43 ↑ 43



\$ 900

P0146101-TW銅旋轉噴頭
不銹鋼裝飾蓋

↔ 64 ∅ 51



▶ 花灑軟管



\$ 300

P0141401-TW

不銹鋼編制軟管

軟管長 1500 螺牙 G1/2



\$ 500

P01413XX-TW

PVC花灑軟管

軟管長 1500 螺牙 G1/2



\$ 600

P0141101-TW

銅編制軟管 (大管徑)

軟管長 1500 螺牙 G1/2



▶ 花灑壁管組



\$ 400

P0128437-TW1

不銹鋼材質

↔ 413 ↑ 161



\$ 1,300

P0528101-TW

銅材質

↔ 320 ↑ 120



\$ 1,500

P0428101-TW

銅材質

↔ 399 ↑ 50



▶ 花灑壁



\$ 1,500

P0728101-TW

銅材質

↔ 68 ↔ 88 ↑ 42



頂噴



\$ 450

P0227301-TW

塑膠花灑
單功能



\$ 900

P3327301-TW

8" 塑膠花灑
白色面蓋
單功能



\$ 700

P0527437-TW

4" SS304 花灑
單功能



\$ 1,800

P0127401-TW

6" SS304 花灑
單功能



\$ 800

P1427301-TW

6" 塑膠花灑
單功能



\$ 500

P0327301-TW

4" 塑膠花灑
單功能



\$ 1,600

P0227401-TW

6" SS304 花灑
單功能



\$ 2,000

P0327401-TW

8" SS304 花灑
單功能



\$ 950

P3427301-TW

8" 塑膠花灑
單功能



\$ 1,300

P1527301-TW

6" 塑膠花灑
單功能



\$ 1,750

P0427401-TW

8" SS304 花灑
單功能



\$ 18,000

P2127401-TW

SUS304 不銹鋼材質
兩功能
帶瀑布出水



\$ 1,100

P3227301-TW

10" 塑膠花灑
白色面蓋
雙功能



\$ 1,500

P3527301-TW

8" 塑膠花灑
單功能



\$ 750

P0627437-TW

4" SS304 花灑
單功能



\$ 18,000

P2227401-TW

SUS304 不銹鋼材質
兩功能
帶瀑布出水



手握花灑



§ 410
P0331301-TW

塑膠手握花灑
吸氣起泡功能
單功能



§ 330
P0231301-TW

塑膠手握花灑
單功能



§ 730
P3231301-TW

塑膠手握花灑
吸氣起泡功能
三功能



§ 750
P1231301-TW

塑膠手握花灑
吸氣起泡功能
單功能



§ 900
P3431301-TW

塑膠材質
白色面蓋
吸氣起泡功能
二功能



§ 1,050
P3031301-TW

塑膠手握花灑
吸氣起泡功能
三功能



§ 1,200 **NEW**
P3831301-TW

中空手握花灑
花灑頭左右擺動控制出水方式
二功能 (正常出水和雨絲氣泡出水)



§ 1,200 **NEW**
P3531301-TW

塑膠手握花灑
吸氣起泡功能
三功能



出水口



§ 600
P0529501-TW

鋅合金材質
不帶提拉換向功能



§ 550
P0129501-TW

鋅合金材質
帶提拉換向功能



§ 750
P0229501-TW

鋅合金材質
帶提拉換向功能



§ 1,270
P0329501-TW

鋅合金材質
帶提拉換向功能



§ 1,000
P0929501-TW

鋅合金材質
不帶提拉換向功能



§ 2,200
P1329101-TW

銅材質
不帶提拉換向功能



§ 1,200
P0829501-TW

鋅合金材質
帶提拉換向功能



§ 2,500
P1229101-TW

銅材質
不帶提拉換向功能



§ 5,500
P0129401-TW

銅材質
銅材質主體
不帶提拉換向功能



▶ 入牆淋浴、淋浴浴缸本體組 / 入牆閥面飾件

▶ 入牆上按壓淋浴浴缸本體組 / 入牆閥面飾件

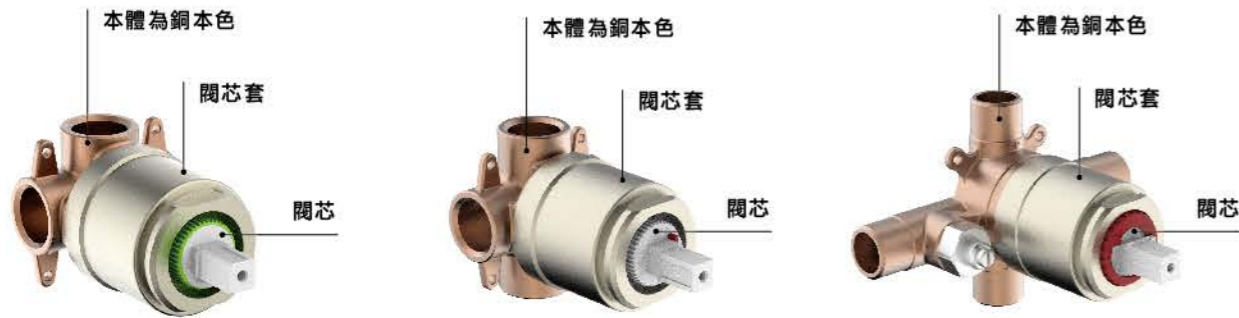

A
\$ 3,300 歐式淋浴 單出水

P06231XX-TW

§ 40陶瓷閥芯
銅材質主體



B
\$ 4,000 歐式浴缸 雙出水

P04231XX-TW

§ 40陶瓷閥芯
銅材質主體



C
\$ 5,800 浴缸 雙出水

P02231XX-TW

§ 40陶瓷平衡閥閥芯
銅材質主體

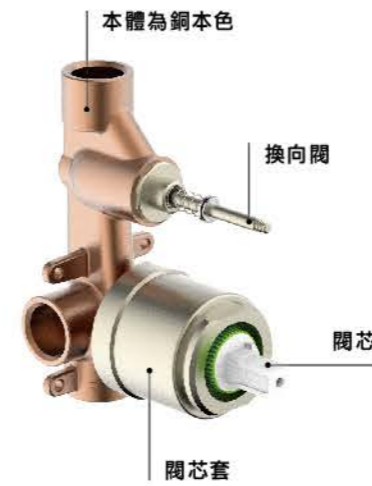

\$ 5,300 歐式浴缸 雙出水

P08231XX-TW

§ 40陶瓷閥芯
銅材質主體
按壓式換向閥

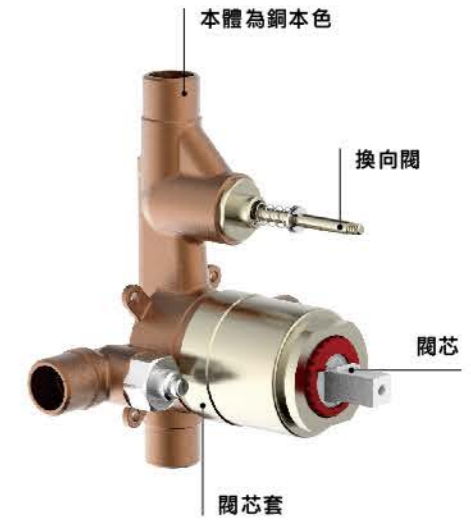

\$ 6,600 浴缸 雙出水

P03231XX-TW

§ 40陶瓷平衡閥閥芯
銅材質主體
按壓式換向閥



\$ 1,250

P0621401-TW

面飾件
金屬材質把手
不銹鋼面板

適配 A B 本體組



\$ 1,500

P0121301-TW

面飾件
金屬材質把手
塑膠面板

適配 A B C 本體組



\$ 1,300

P0221301-TW

面飾件
金屬材質把手
塑膠面板

適配 A B C 本體組



\$ 1,700

P0521301-TW

面飾件
金屬材質把手
塑膠面板

適配 A B C 本體組



\$ 2,500

P0121101-TW

面飾件
金屬材質把手
銅面板

適配 A B C 本體組



\$ 4,300

P2021101-TW

面飾件
金屬材質把手
3mm銅面板

適配 A B C 本體組



\$ 1,500 雙出水

P0222301-TW

面飾件
金屬材質把手
塑膠面板
適配上按壓淋浴浴缸本體組



\$ 2,800 雙出水

P0122101-TW

面飾件
金屬材質把手
銅面板
適配上按壓淋浴浴缸本體組



\$ 2,000 雙出水

P0122301-TW

面飾件
金屬材質把手
塑膠面板
適配上按壓淋浴浴缸本體組



\$ 4,800 雙出水

P2022101-TW

面飾件
金屬材質把手
3mm銅面板
適配上按壓淋浴浴缸本體組



▶ 入牆恆溫閥本體組 / 入牆閥面飾件

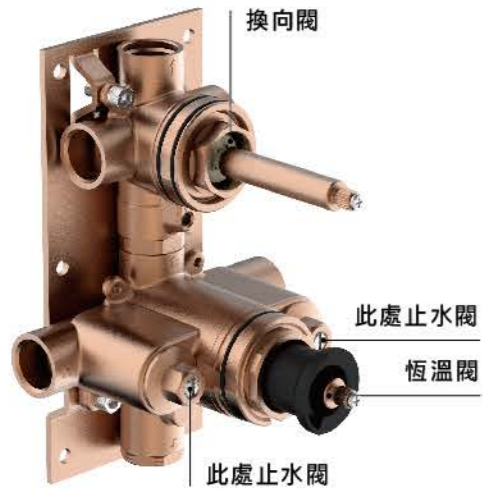

§ 12,500 帶3通分水器

P20231XX-TW

恆溫閥芯
銅材質主體



§ 5,900

P2222101-TW

面飾件
銅材質把手
3mm銅面板
適配恆溫閥本體組



§ 7,300

P2122101-TW

面飾件
銅材質把手
3mm銅面板
適配恆溫閥本體組



▶ 入牆分水器本體組



§ 3,000 1進水 2出水

P12231XX-TW

陶瓷閥芯
帶關閉功能



§ 3,100 1進水 3出水

P13231XX-TW

陶瓷閥芯
不帶關閉功能



▶ 入牆閥面飾件 (含入牆本體組)

§ 1,500

P0721401-TW

入牆閥面飾件

面飾件
銅把手
不銹鋼面板



§ 5,000 單出水

P0561301-TW

入牆龍頭面板閥體組

金屬材質把手
塑料面板
陶瓷閥芯(Φ40)
銅材質淋浴入牆本體組



§ 7,000 雙出水

P0362301-TW

入牆龍頭面板閥體組

金屬材質把手
塑膠面板
陶瓷閥芯(Φ40)
銅材質上按壓淋浴浴缸入牆本體組
按壓式換向閥



§ 9,000 雙出水

P0962101-TWB

入牆平衡龍頭面板閥體組

金屬材質把手
銅材質面板
陶瓷壓力平衡閥芯(Φ40)
銅材質上按壓淋浴浴缸入牆本體組
按壓式換向閥



§ 2,000

P0821401-TW

入牆閥面飾件

面飾件
銅把手
不銹鋼面板



§ 5,700 雙出水

P0561301-TW1

入牆龍頭面板閥體組

金屬材質把手
塑料面板
陶瓷閥芯(Φ40)
銅材質淋浴浴缸入牆本體組



§ 8,000 雙出水

P1161101-TWB

入牆平衡龍頭面板閥體組

金屬材質把手
銅材質面板
陶瓷壓力平衡閥芯(Φ40)
銅材質淋浴浴缸入牆本體組



§ 18,000 帶3通分水器

P2262101-TWS

入牆恆溫龍頭面板閥體組

金屬材質把手
3mm銅面板
恆溫閥芯
銅材質恆溫閥入牆本體組



▶ 角閥



\$ 240
P0142101-TW
 SUS304不銹鋼材質
 ↳ 66 ∅ 49 ↓ 55



NEW \$ 300
P0242428-TW
 SUS304不銹鋼材質 (加長版)
 ↳ 29 ↳ 45 ↓ 109

▶ 洗衣機龍頭

NEW



\$ 900
P0742101-TW
 金屬材質把手
 銅材質主體
 ↳ 107 ↳ 46 ↓ 129

▶ 噴槍

NEW



\$ 500
P0247301-TW
 塑膠材質
 帶軟管
 帶插座
 噴槍
 ∅ 29 ↳ 76 ↓ 109
 花灑插座
 ↳ 52 ∅ 35
 軟管
 ↓ 1200



\$ 600
P0347301-TW
 塑膠材質
 帶軟管
 帶插座
 噴槍
 ∅ 30 ↳ 65 ↓ 114
 花灑插座
 ↳ 52 ∅ 35
 軟管
 ↓ 1200

▶ 無鉛銅鍛進水彎頭

Lead Free Copper Forged Elbow

快速拆裝 方便清洗



A 止水閥關閉後，不需要關閉自來水總閥便可以拆卸、更換、維修龍頭。



A 止水閥關閉後，不需要關閉自來水總閥便可以拆卸、更換、維修龍頭。

在關閉 A 止水閥後，通過拆卸 C 接頭，可以達到不需要拆卸龍頭就可以沖洗更換 B 濾網
(目前市場大部分的掛牆淋浴、掛牆浴缸龍頭需要清洗進水濾網，都需要關閉總閥或關閉止水閥後拆卸整個龍頭才能沖洗進水濾網)

快速拆裝



\$ 950
P0542101-TW
 進水彎頭 (2/組)
 無鉛銅材質
 帶止水開關
 ↳ 54 ∅ 64 ↓ 83



\$ 1,250
P0642101-TW
 進水彎頭 (2/組)
 無鉛銅材質
 帶止水開關
 帶濾網
 ↳ 52 ∅ 64 ↓ 88

Bathroom Accessories 浴室配件

紙巾盒



§ 750

Y2323137-TW

SS304材質

↳ 124 ↔ 128 ↓ 126



§ 750

Y2423137-TW

SS304材質

↳ 122 ↔ 250 ↓ 251



美容鏡



§ 2,000

Y3523101-TW

銅材質



護把



§ 3,300

Y3623128-TW

SS304材質



§ 7,300

Y3723128-TW

SS304材質



§ 2,500

Y3823128-TW

SS304材質



§ 2,900

Y3923128-TW

SS304材質





銀髮系列



“Silver Hair”
Products

"Silver Hair" Products 銀髮系列 NEW

▶ 恆溫大流量羅馬浴缸龍頭



§ 14,900

S7424701-TW

銅材質把手
銅材質主體
Vernet恆溫大流量閥芯
含單功能花灑，花灑插座
1500mm花灑軟管

▶ 走入式浴缸



§ 150,000

Y46292XX-TW

壓克力材質

▶ 扶把



§ 1,600

Y36292XX-TW

L型扶把

不銹鋼架
白色ABS材質防滑套



§ 1,000

Y38292XX-TW

一字扶把

不銹鋼架
白色ABS材質防滑套



§ 1,800

Y37292XX-TW

落地扶把

不銹鋼架
白色ABS材質防滑套



§ 7,000

Y43292XX-TW

折疊扶把

不銹鋼架
白色ABS材質防滑套

▶ 扶椅



§ 6,000

Y42292XX-TW

不銹鋼架
白色ABS材質防滑套



產品尺寸工程圖

◆
**Product
Technical
Drawings**

Bathroom faucet 浴室龍頭

▶ 單把臉盆龍頭

Single Control Lavatory Faucet



W3180601-TW1 17
Dazzle 迪佐



W3180101-TW1 18
Vogue 樂活



W3290101-TW4 18
Vogue 樂活



W8129101-TW4 19
Rotunda 星動



W3123001-TW1 19
Rotunda 星動



W3280201-TW1 19
Rotunda 星動



W3480201-TW4 19
Rotunda 星動

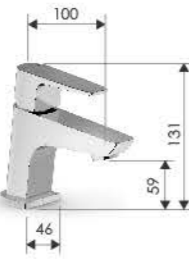

W3280701-TW4 21
Elliptic 伊利普

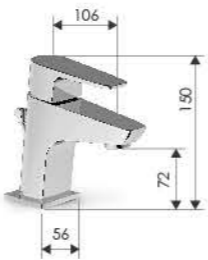

W3180701-TW1 21
Elliptic 伊利普



W8181801-TW4 23
Splice 普萊斯



W8181834-TW4 23
Splice 普萊斯
鍍鉻+白漆



W8181838-TW4 23
Splice 普萊斯
鍍鉻+黑漆

▶ 單把臉盆龍頭

Single Control Lavatory Faucet



W3181301-TW1 23
Splice 普萊斯



W3181331-TW1 23
Splice 普萊斯
抗菌拉絲鍍



W3180501-TW1 27
Casement 凱西蒙



W3181501-TW1 29
Portico 波帝克

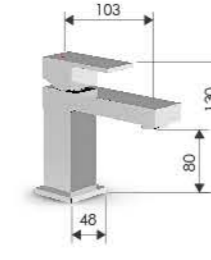

W8160801-TW1 31
Trim 魔方

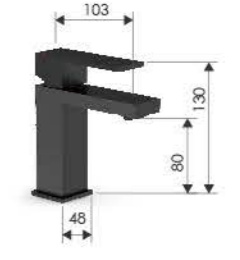

W8160838-TW1 31
Trim 魔方
啞光黑

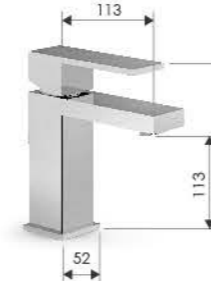

W3160801-TW1 31
Trim 魔方



W3160838-TW1 31
Trim 魔方
啞光黑



W3160501-TW1 34
Essence 伊聖斯



W3180901-TW1 35
Crisscross 酷仕

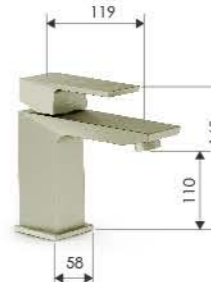

W3180902-TW1 35
Crisscross 酷仕
拉絲鍍PVD

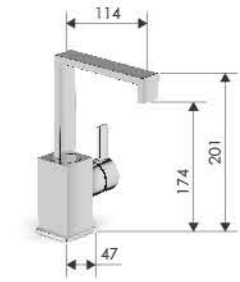

W3160401-TW24 36
Ultra 歐賽

▶ 單把臉盆龍頭

Single Control Lavatory Faucet

▶ 單把高腳臉盆龍頭

Single Control Vessel Filler Faucet

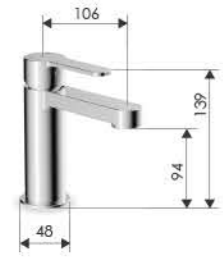

W3181601-TW14 38
Flicker 菲利克

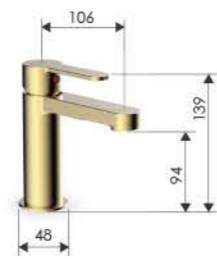

W3181635-TW14 38
Flicker 菲利克
玫瑰金PVD



W8181601-TW14 38
Flicker 菲利克



W8181635-TW14 38
Flicker 菲利克
玫瑰金PVD

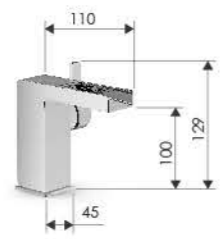

W3181701-TW4 39
Waterfall 瀑布



W8181701-TW4 39
Waterfall 瀑布



W8180501-TW4 39
Waterfall 瀑布

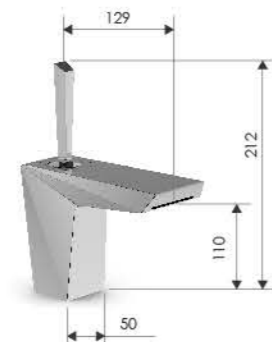

W3180801-TW4 40
Waterfall 瀑布



W3180813-TW4 40
Waterfall 瀑布
青銅PVD



W3580601-TW4 17
Dazzle 迪佐



W3580101-TW4 18
Vogue 樂活



W3680201-TW4 19
Rotunda 星動



W3580701-TW14 21
Elliptic 伊利普



W3581301-TW4 23
Splice 普萊斯



W3580501-TW4 27
Casement 凱西蒙

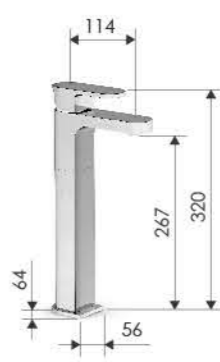

W3581501-TW4 29
Portico 波帝克



W3560801-TW4 31
Trim 魔方

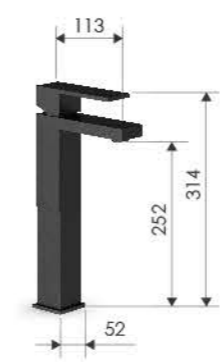

W3560838-TW4 31
Trim 魔方
啞光黑



W3581601-TW14 38
Flicker 菲利克

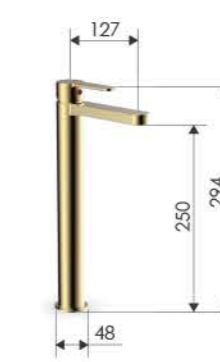

W3581635-TW14 38
Flicker 菲利克
玫瑰金PVD

▶ 雙把3孔分離式臉盆龍頭 8" Wide Spread Faucet



W4580201-TW1 20
Rotunda 星動
中心間距各76-153

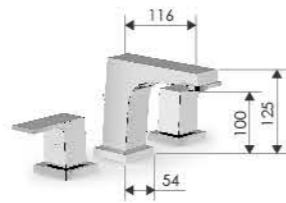

W4580501-TW1 27
Casement 凱西蒙
中心間距各102

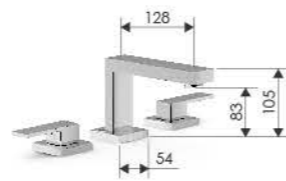

W4560801-TW4 32
Trim 魔方
中心間距各76-153

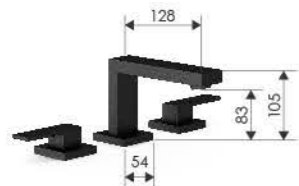

W4560838-TW4 32
Trim 魔方
啞光黑
中心間距各76-153



W4561201-TW1 33
Edin 伊登
中心間距各102

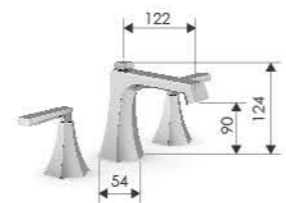

W4560501-TW1 34
Essence 伊聖斯
中心間距各76-153

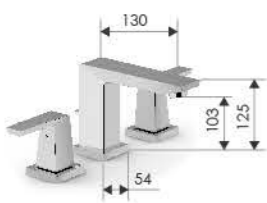

W4580901-TW1 35
Crisscross 酷仕
中心間距各76-153

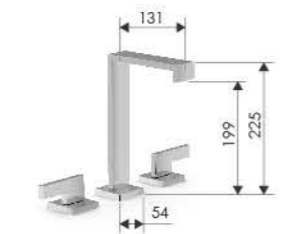

W4560401-TW24 36
Ultra 歐賽
中心間距各76-153

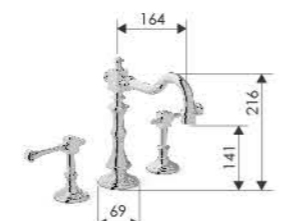

W4560301-TW4 37
Vintage 干邑
中心間距各76-153

▶ 雙把3孔分離式入牆臉盆龍頭 Wall-mounted Basin Mixer

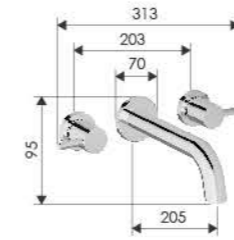

W4880201-TW14 20
Rotunda 星動

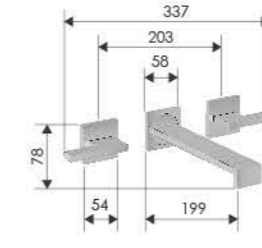

W4860401-TW24 36
Ultra 歐賽

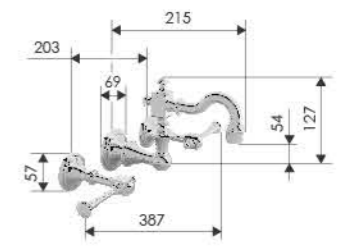

W4860301-TW4 37
Vintage 干邑

▶ 雙把3孔分離式-浴缸龍頭 3 pc Roman Tub Filler Faucet



S7380201-TW 20
Rotunda 星動
中心間距各76-102

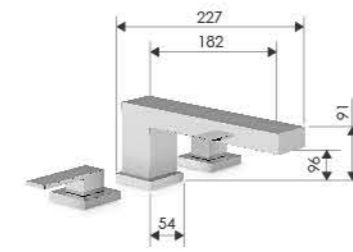

S7382001-TW 32
Trim 魔方
中心間距各76-102

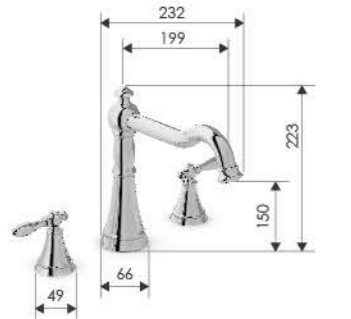

S7361201-TW 33
Edin 伊登
中心間距各76-102

▶ 單把2孔入牆臉盆龍頭 Wall-mounted Single-lever Basin Mixer

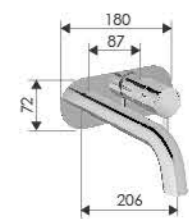

W8880201-TW4 20
Rotunda 星動

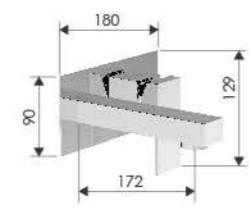

W8880501-TW4 27
Casement 凱西蒙

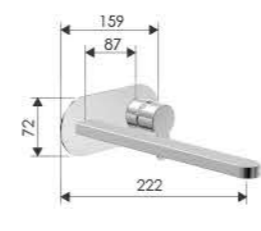

W3881601-TW14 38
Flicker 菲利克



S7360501-TW1 34
Essence 伊聖斯
中心間距各76-102

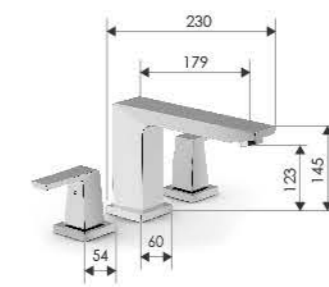

S7380901-TW1 35
Crisscross 酷仕
中心間距各76-102

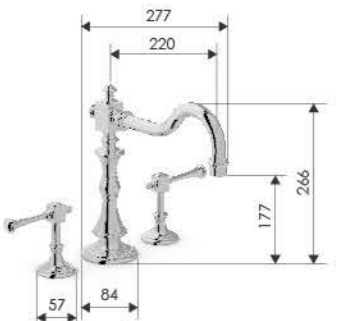

S7360301-TW 37
Vintage 干邑
中心間距各76-102

▶ 單把3孔分離式-浴缸龍頭

Single Lever Roman Tub Filler Faucet With Transfer Valve

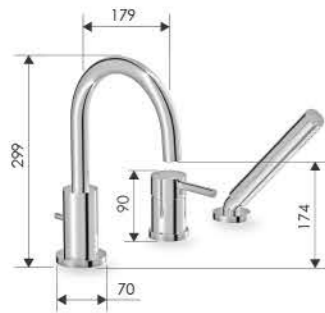

S9380201-TW 20
Rotunda 星動
花灑高度 204

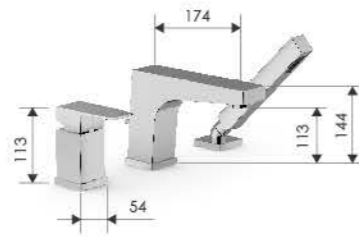

S7380501-TW1 28
Casement 凱西蒙
花灑高度 210

▶ 雙把4孔分離式-浴缸龍頭

4-hole Roman Tub Filler Faucet

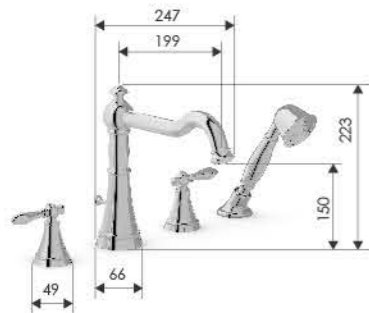

S7461201-TW 33
EdIn 伊登
花灑高度 165
中心間距各 76-102

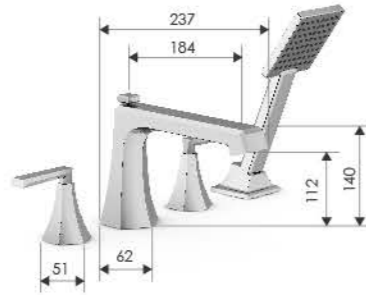

S7460501-TW1 34
Essence 伊里斯
花灑高度 242
中心間距各 76-102

▶ 雙把5孔分離式-浴缸龍頭

5 pc Roman Tub Filler Faucet

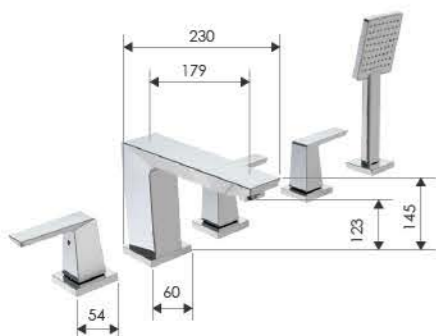

S7580901-TW1 35
Crisscross 酷仕
花灑高度 244
中心間距各 76-102

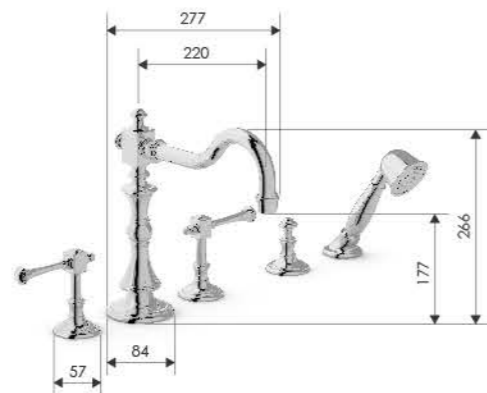

S7560301-TW 37
Vintage 干邑
花灑高度 159
中心間距各 76-102

▶ 單把掛牆-淋浴龍頭

Wall-mounted Single-lever Shower Mixer

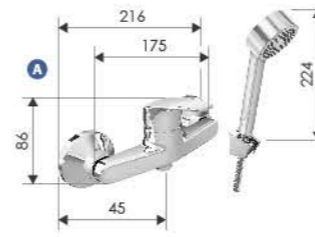

S5180601-TW 17
Dazzle 迪佐
W51806N01-TW

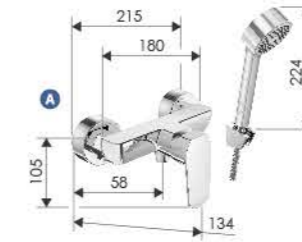

S5180101-TW 18
Vogue 樂活
W51801N01-TW

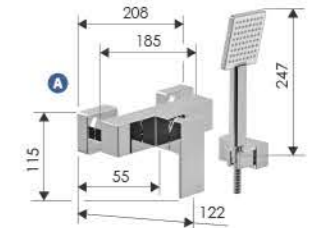

S5180501-TW 28
Casement 凱西蒙
W51805N01-TW

▶ 單把掛牆-淋浴浴缸龍頭

Wall-mounted Single-lever Bath Mixer



S5380601-TW 17
Dazzle 迪佐
W53806N01-TW

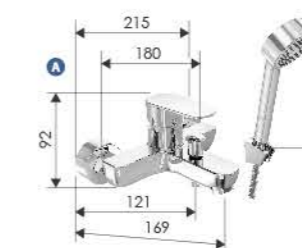

S5380101-TW 18
Vogue 樂活
W53801N01-TW

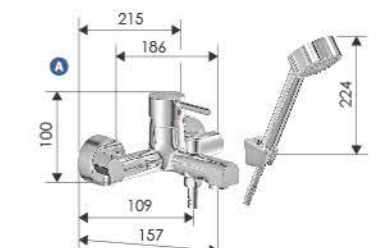

S5380201-TW 20
Rotunda 星動
W53802N01-TW

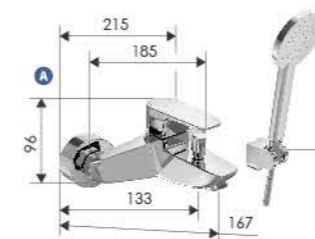

S5380701-TW 21
Elliptic 伊利普
W53807N01-TW

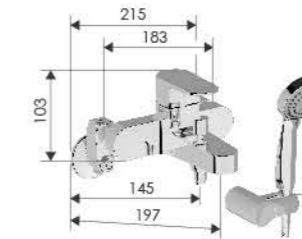

S5480701-TW 22
Elliptic 伊利普

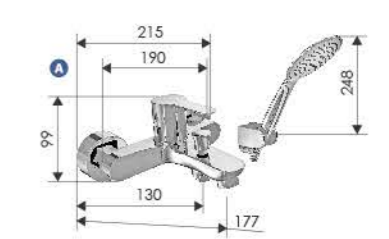

S5381301-TW 24
Splice 普萊斯
W53813N01-TW

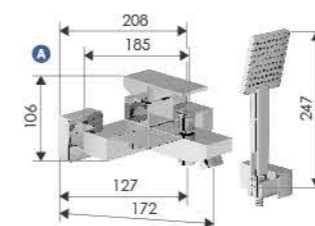

S5380501-TW 28
Casement 凱西蒙
W53805N01-TW

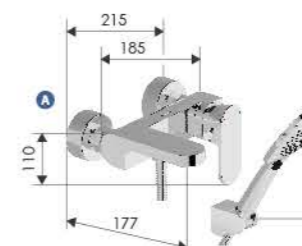

S5381501-TW1 29
Portico 波帝克
W53815N01-TW

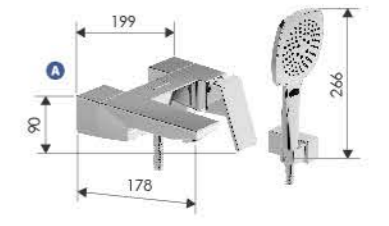

S5380901-TW1 35
Crisscross 酷仕
W53809N01-TW

掛牆淋浴龍頭&掛牆淋浴浴缸龍頭之掛牆安裝中心距離152mm

▶ 掛牆淋浴恒溫龍頭
Thermostatic shower system

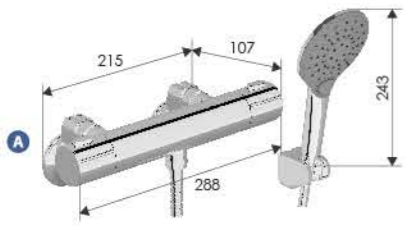

S5202401-TW1 26
Splice 普萊斯
A W52024N01-TW

▶ 掛牆淋浴浴缸恒溫龍頭
Thermostatic tub & shower system

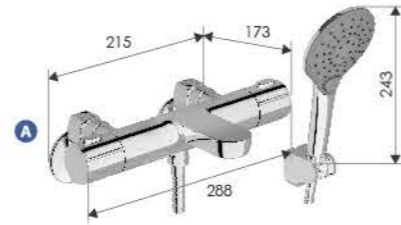

S54024 26
Splice 普萊斯
A W54024N01-TW

▶ 單把掛牆-淋浴雙花灑龍頭
Wall-mount ceiling shower & hand shower system

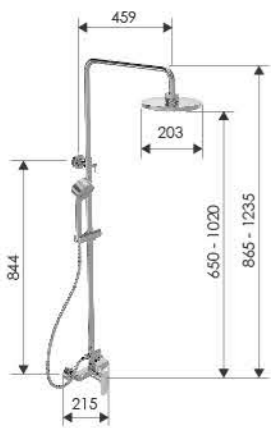

S5780101-TW 55
Vogue 樂活

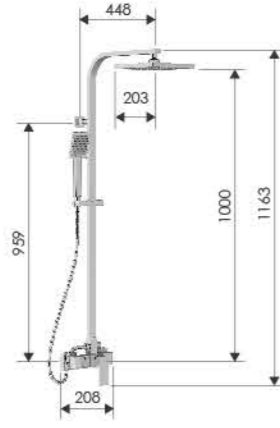

S5780501-TW 55
Casement 凱西蒙

▶ 單把掛牆-淋浴浴缸雙花灑龍頭
Wall-mount ceiling shower & hand shower tub system

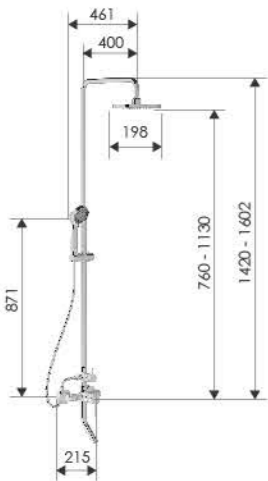

S5980201-TW 55
Rotunda 星動

▶ 掛牆恒溫
淋浴浴缸雙花灑龍頭
Thermostatic tub & shower system

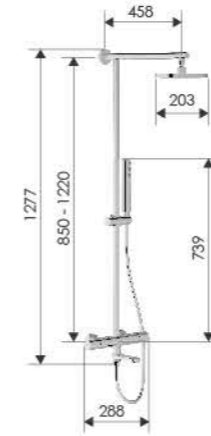

S5902401-TW 56
Splice 普萊斯

▶ 雙花灑升降杆組
Slide shower bar

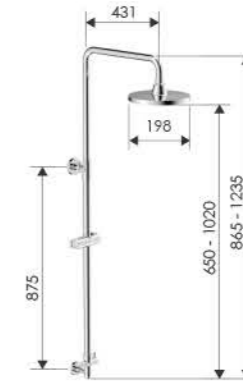

P0134101-TW1 56
Rotunda 星動

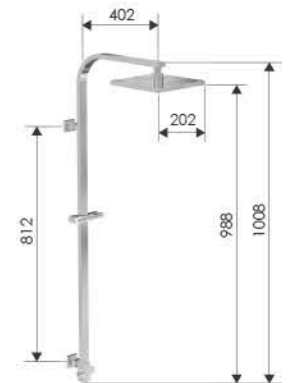

P0234101-TW1 56
Casement 凱西蒙

▶ 掛牆-雙花灑置物盒龍頭 **NEW**
Wall-mount ceiling shower and hand shower system

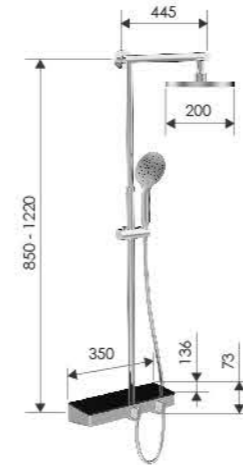

S5528901-TW 59
淋浴



S5728901-TW 59
淋浴浴缸

▶ 掛牆-單花灑置物盒龍頭 **NEW**
Wall-mounted single-lever bath mixer

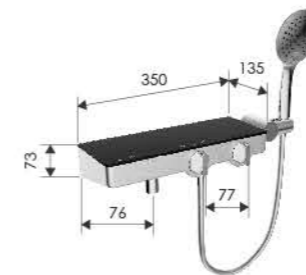

S5328901-TW 59
淋浴浴缸

▶ 掛牆恆溫-雙花灑置物盒龍頭 **NEW**

Wall-mount thermostatic ceiling shower and hand shower system

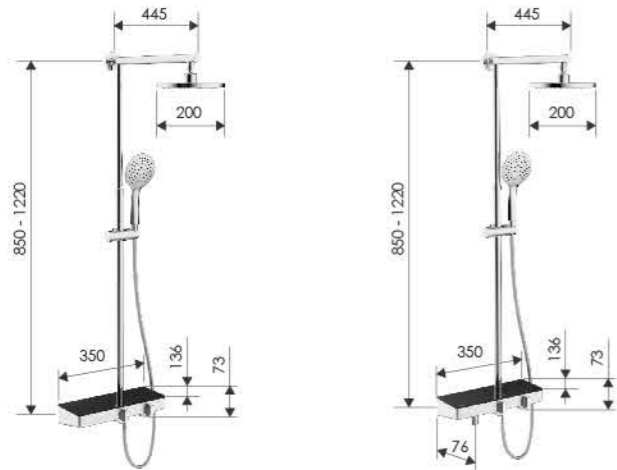

S5529001-TW 60
恆溫-淋浴

S5729001-TW 60
恆溫-淋浴浴缸

▶ 掛牆恆溫-單花灑置物盒龍頭 **NEW**

Wall-mounted thermostatic single-lever and bath mixer

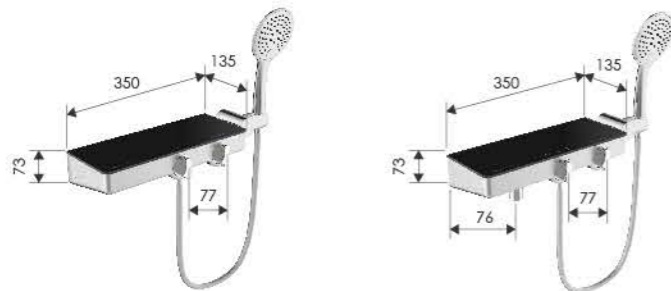

S5129001-TW 60
恆溫-淋浴

S5329001-TW 60
恆溫-淋浴浴缸

▶ 單把落地浴缸龍頭

Free standing tub filler

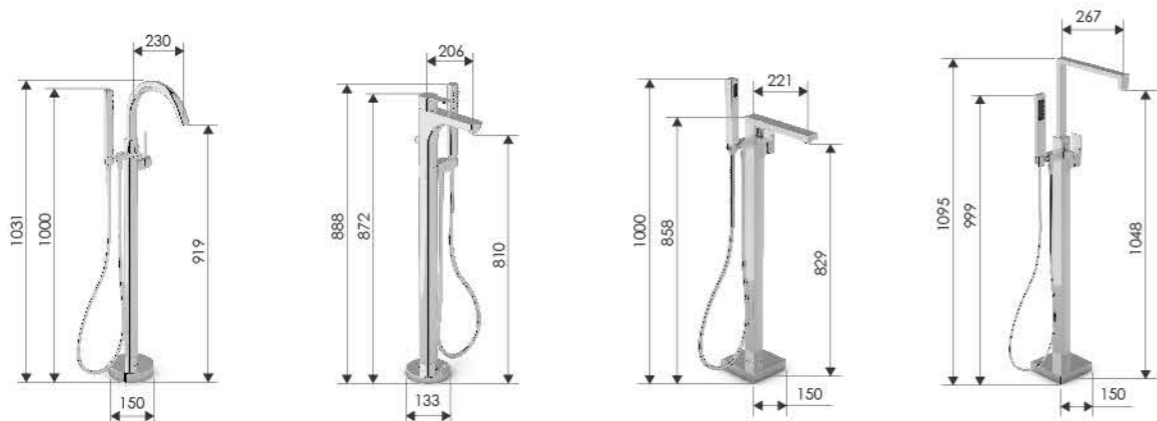

S7660701-TW 71
Rotunda 星動

S7881301-TW 71
Splice 普萊斯

S7880501-TW 71
Trim 魔方

S7860401-TW1 71
Ultra 歐賽

Kitchen 廚房龍頭

▶ 單把廚房龍頭

Single control kitchen system

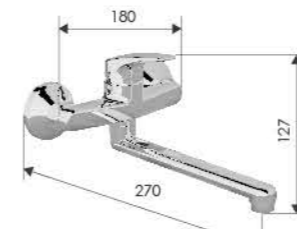

K3780601-TW 45

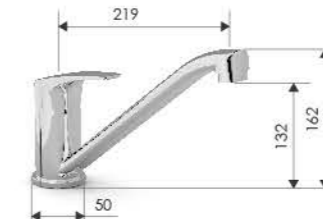

K1280601-TW 45



K1280201-TW 45



K1260401-TW1 45



K1281501-TW 45

▶ 單把上拉式廚房龍頭

Single control kitchen pull-out faucet

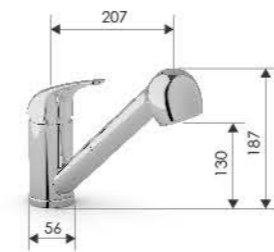

K1680001-TWQ 46



K1680201-TWR 46

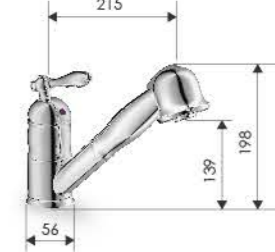

K1661201-TWS 46



K1623901-TWPF 46

▶ 單把下拉式廚房龍頭
Single control kitchen pull-down system

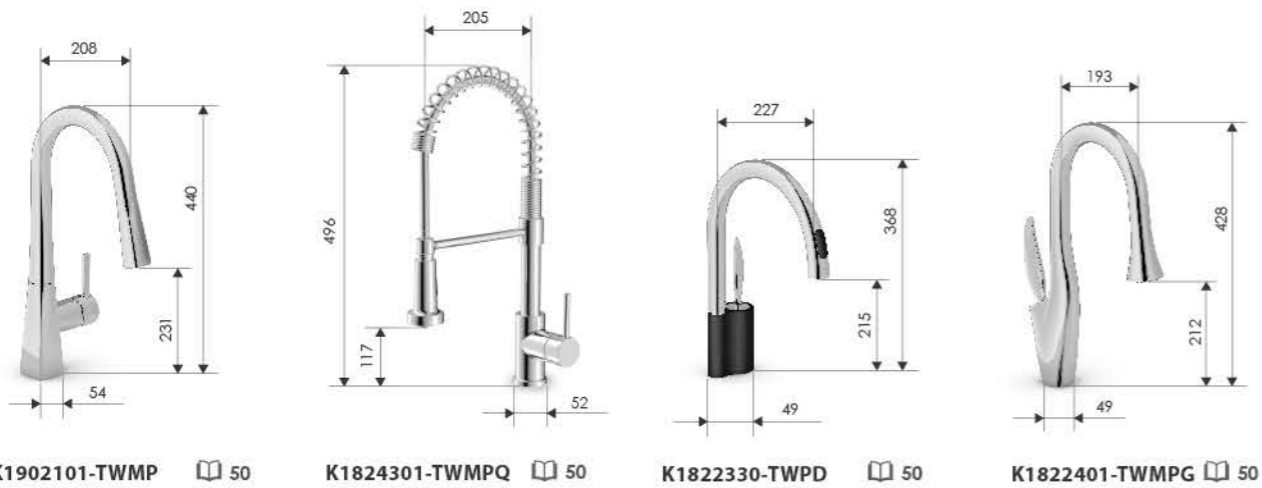
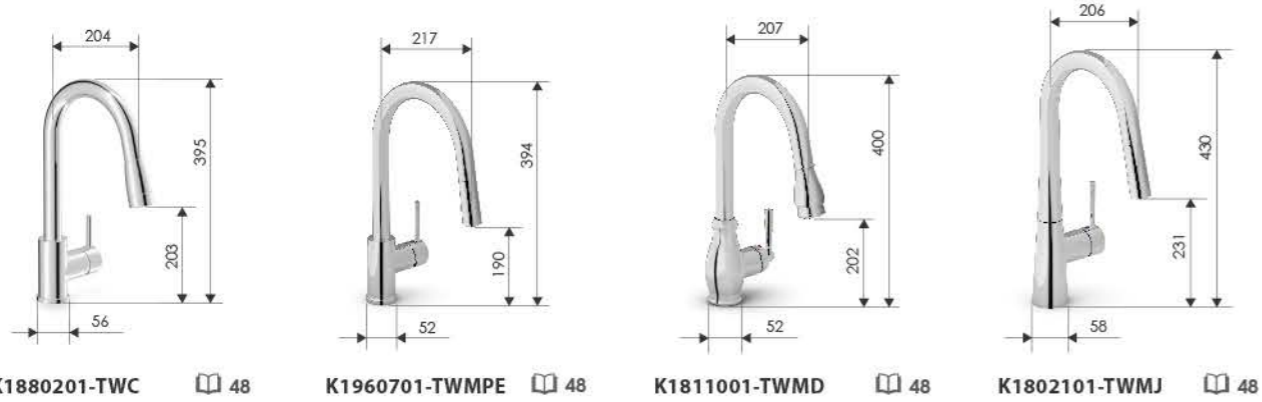

SUS304 不銹鋼龍頭

▶ 不鏽鋼-浴室臉盆龍頭
SUS304 - Bathroom faucet

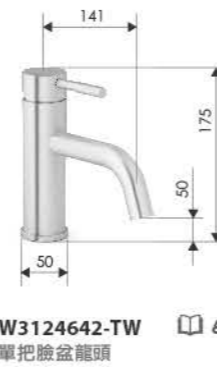

▶ 不鏽鋼-廚房龍頭
SUS304 - Kitchen faucet

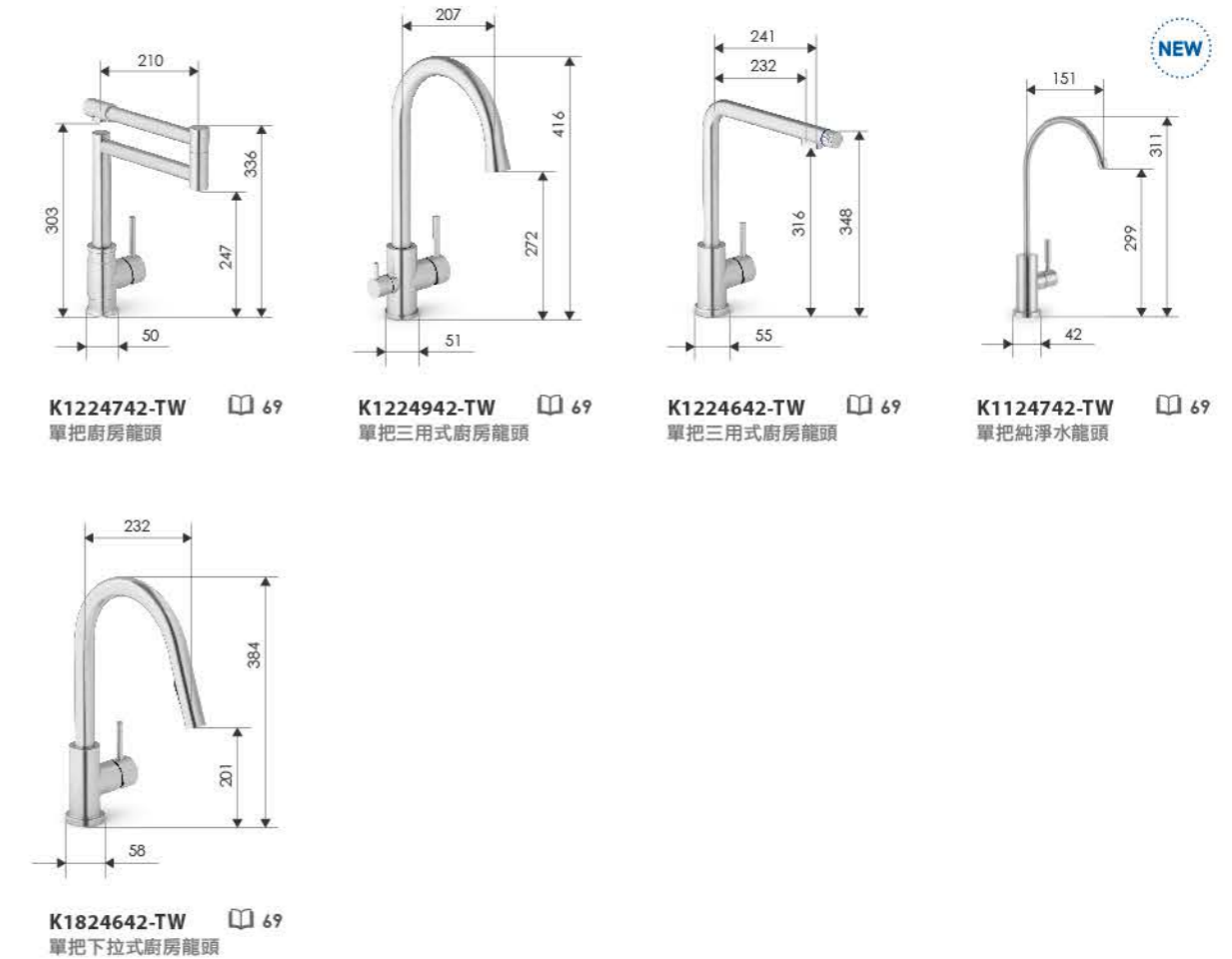

Shower & Bath Accessories 淋浴配件

排水組

Drain Assemblies or Pop-up Assemblies



P0111101-TW 83
提拉式銅排桿

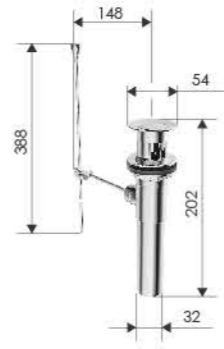

P0111101-TW1 83
提拉式銅排桿

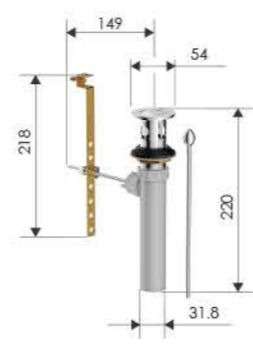

P0111201-TW 83
美式半銅塑排桿

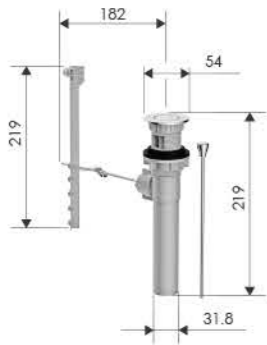

P0111301-TW 83
美式塑膠排桿



P0612101-TW 83
手按式排桿



P0112101-TW 83
手按式排桿



P0112101-TW1 83
手按式排桿



P0211101-TW 83
歐式銅排桿



P0211301-TW 83
歐式塑膠排桿

頂噴 Shower head

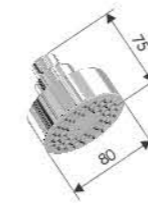

P0227301-TW 87
塑膠花灑



P1427301-TW 87
6"塑膠花灑

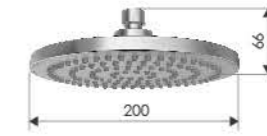

P3427301-TW 87
8"塑膠花灑



P3227301-TW 87
10"塑膠花灑

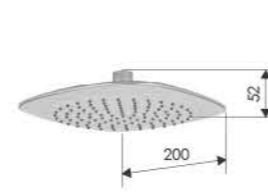

P3327301-TW 87
8"塑膠花灑

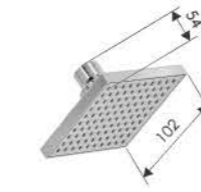

P0327301-TW 87
4"塑膠花灑



P1527301-TW 87
6"塑膠材質

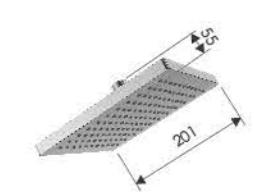

P3527301-TW 87
8"塑膠材質



P0527437-TW 88
4"SS304花灑



P0227401-TW 88
6"SS304花灑



P0427401-TW 88
8"SS304花灑



P0627437-TW 88
4"SS304花灑



P0127401-TW 88
6"SS304花灑



P0327401-TW 88
8"SS304花灑

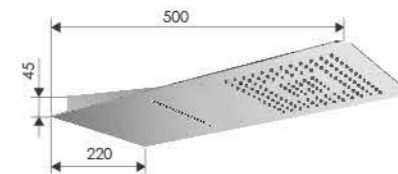

P2127401-TW 88
SUS304不銹鋼材質

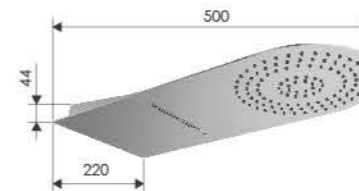

P2227401-TW 88
SUS304不銹鋼材質

手握花灑
Hand shower

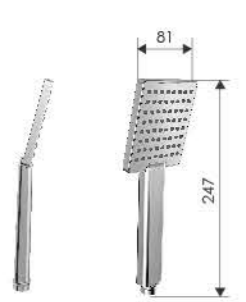

P0331301-TW 89
單功能



P3231301-TW 89
三功能

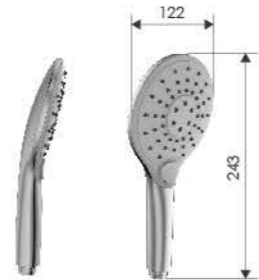

P3431301-TW 89
二功能



P3831301-TW 89
二功能

NEW



P0231301-TW 89
單功能



P1231301-TW 89
單功能



P3031301-TW 89
三功能



P3531301-TW 89
三功能

NEW

入牆淋浴、淋浴浴缸本體組 / 入牆閥面飾件
Rough-In Valve, PB Rough-In Valve / Valve trim w/o diverter



P06231XX-TW 91
歐式入牆淋浴本體組 (單出水)

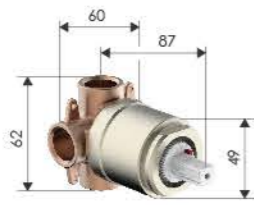

P04231XX-TW 91
歐式入牆浴缸本體組 (雙出水)

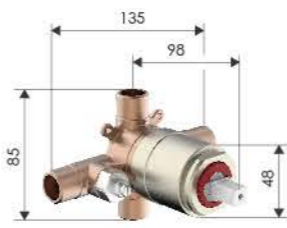

P02231XX-TW 91
入牆浴缸本體組 (雙出水)

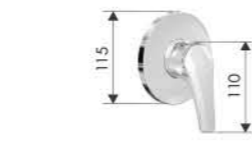

P0621401-TW 91
入牆閥面飾件 (單出水)

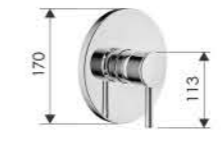

P0221301-TW 91
入牆閥面飾件 (雙出水)



P0121301-TW 91
入牆閥面飾件 (雙出水)

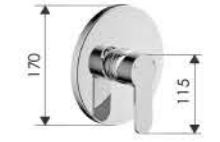

P0521301-TW 91
入牆閥面飾件 (雙出水)

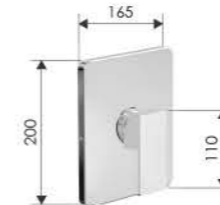

P0121101-TW 91
入牆閥面飾件 (雙出水)

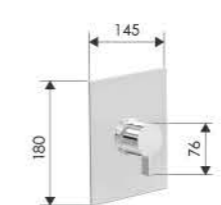

P2021101-TW 91
入牆閥面飾件 (雙出水)

入牆上按壓淋浴浴缸本體組 / 入牆閥面飾件
Rough-In Valve / Valve trim w/ diverter

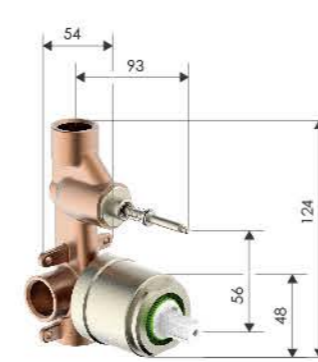

P08231XX-TW 92
歐式入牆上按壓淋浴浴缸本體組 (雙出水)

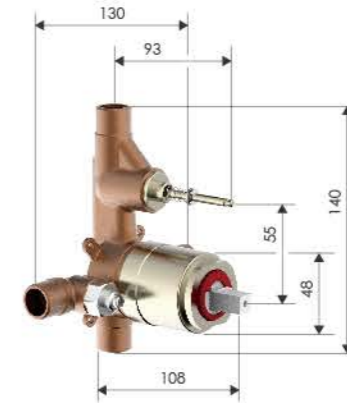

P03231XX-TW 92
入牆上按壓淋浴浴缸本體組 (雙出水)



P0222301-TW 92
入牆閥面飾件 (雙出水)

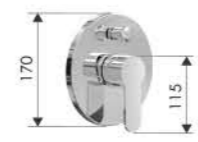

P0122301-TW 92
入牆閥面飾件 (雙出水)

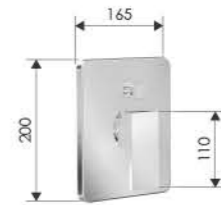

P0122101-TW 92
入牆閥面飾件 (雙出水)

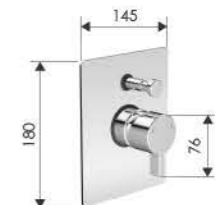

P2022101-TW 92
入牆閥面飾件 (雙出水)

▶ 入牆恒溫閥本體組 / 入牆閥面飾件
Rough-In Valve / Thermostatic valve trim

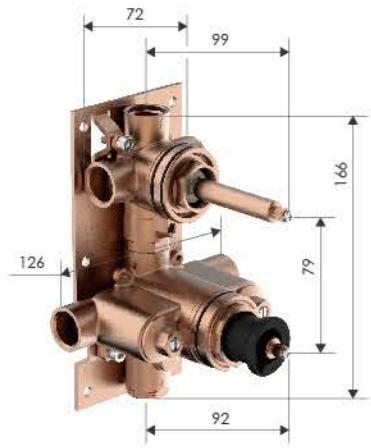

P20231XX-TW 93
入牆恒溫閥本體組 (3通分水)

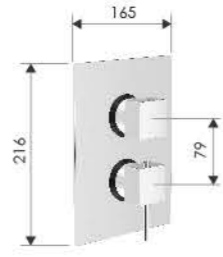

P2122101-TW 93
入牆閥面飾件

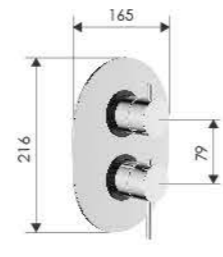

P2222101-TW 93
入牆閥面飾件

▶ 入牆分水器本體組
Diverter Valve



P12231XX-TW 93
入牆分水器本體組 (1進水 2出水)



P13231XX-TW 93
入牆分水器本體組 (1進水 3出水)

▶ 入牆閥面飾件 (含入牆本體組)
diverter trim

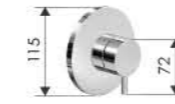

P0721401-TW 94
入牆閥面飾件



P0821401-TW 94
入牆閥面飾件

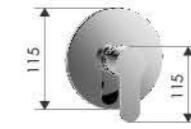

P0561301-TW 94
入牆閥面飾件 (單出水)



P0561301-TW1 94
入牆閥面飾件 (雙出水)

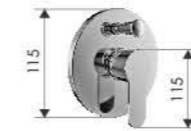

P0362301-TW 94
入牆閥面飾件 (雙出水)

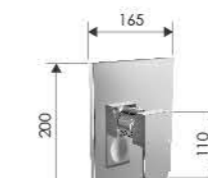

P1161101-TWB 94
入牆閥面飾件 (雙出水)



P0962101-TWB 94
入牆閥面飾件 (雙出水)

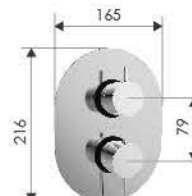

P2262101-TWS 94
入牆閥面飾件 (3通分水)

▶ 出水口
Tub Spout



P0529501-TW 90



P0229501-TW 90

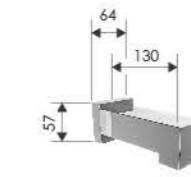

P0929501-TW 90

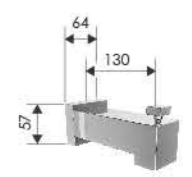

P0829501-TW 90

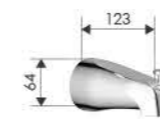

P0129501-TW 90

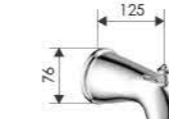

P0329501-TW 90

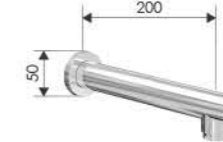

P1329101-TW 90

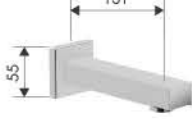

P1229101-TW 90

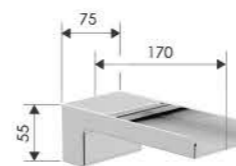

P0129401-TW 90

“Silver Hair” Products 銀髮系列 NEW

▶ 恆溫大流量羅馬浴缸龍頭

Thermostatic tub & shower faucet



S7424701-TW 101

▶ 走入式浴缸

Bathtub



Y46292XX-TW 101

▶ 扶把

Grab bar



Y36292XX-TW 102
L型扶把



Y38292XX-TW 102
一字扶把

▶ 扶椅

Armchair



Y42292XX-TW 102
扶椅



Y37292XX-TW 102
落地扶把



Y43292XX-TW 102
折疊扶把